

Health and Care Partnership Joint Committee

Date: 7.3.2022

Time: 5-8pm

Venue: Virtual meeting via MSTeams

Agenda

No.	Agenda Item	Lead	Purpose	Time
Opening Actions				
1.	Welcome, Introductions and Apologies	Chair	-	5.00
2.	Core Purposes of Integrated Care Systems: <ul style="list-style-type: none"> • improve outcomes in population health and healthcare • tackle inequalities in outcomes, experience and access • enhance productivity and value for money • help the NHS support broader social economic development 	Chair		
3.	Relevant Persons Disclosure of Interests <ul style="list-style-type: none"> • Register of Interests 	Chair	Note changes and approve	
4.	Approval of Minutes and Matters Arising			
5.	Review of Action Tracker			
Strategy				
6.	Health and Care Strategy and five year forward plan	Anne Brierley, Chief of Transformation & Strategy BLMK ICB	Provide an update	5.10
7.	Place plans, Health and Wellbeing Board updates and Health and Wellbeing Board guidance	HWBB Chairs	Update on Place based delivery plan and key items from HWBB	5.40
8.	Delegation of Dentistry, Optometry & Community Pharmacy	Nicky Poulain, Chief Primary Care Officer BLMK ICB	To note	6.10
9.	Mental Health, Learning Disability and Autism collaboration	Richard Fradgley and Ross Graves	Update on programme	6.25

No.	Agenda Item	Lead	Purpose	Time
10.	Community engagement	Michelle Summers/Comms collaborative	Summary of engagement with residents	7.00
Governance				
11.	ICB update	ICB Chair	For information to note	7.30
12.	Communications from the meeting	Chair	Discuss	7.40
13.	Review of meeting effectiveness	Chair	Note	7.45
14.	Annual Cycle of Business (Next meeting Agenda items)	Chair	Discuss	7.50
Closing Actions				
15.	Any Other Business	Chair	-	7.55
16.	Date and time of next meeting: <ul style="list-style-type: none"> ▪ 21 June 2023 at 5-8pm Venue TBC 	Chair	-	

Members are asked to:

> Review the Register of Interests and confirm their entry is accurate and up to date.

All in attendance are asked to:

> Declare any relevant interests relating to matters on the agenda.

> Confirm that all offers of Gifts and Hospitality received in the last 28 days have been registered with the Governance & Compliance team via blmkicb.corporatesec@nhs.net

**Extract from Register of Conflicts of Interest
BLMK Health & Care Partnership
as at 28.2.23**

Surname	Forename	Position within, or relationship with the ICB	Interests to Declare	Type of Interest			Description of Interest	Date From	Date To	Actions to be taken to mitigate risk	Date Declared
				Financial Interest	Non-Financial Professional	Non-Financial Personal					
Barhey	Manraj	PCN Clinical Director, Luton	Yes	Y			Partner at Woodland Avenue Practice, Luton	01/05/1995	Ongoing	Declare in line with conflicts of interest policy	23/08/2022
Barhey	Manraj	PCN Clinical Director, Luton	Yes	Y			Woodland Avenue Practice is a shareholder in EEXIA - GP Federation in Luton	May-95	Ongoing	Exclusion from involvement in related meeting or decision making	23/08/2022
Blackmun	Diana	CEO, Healthwatch Central Bedfordshire	No								05/12/2022
Bradburn	Robin	Deputy Leader MK City Council, member of H&CP	No								03/01/2023
Cartwright	Sally	Director of Public Health, Luton Council	No								22/06/2022
Coffait	Marcel	Chief Executive, Central Bedfordshire Council	Yes	Y			I am the Chief Executive of Central Bedfordshire Council which is an may be commissioned to work on behalf of the ICB	01/11/2020	Ongoing	Declare in line with conflicts of interest policy	27/05/2022
Cox	Felicity	Chief Executive, BLMK ICB	Yes	Y			I am a registered pharmacist with the General Pharmaceutical Council (GPC) and a member of the Royal Pharmaceutical Society	17/08/1987	Ongoing	I will excuse myself should an interest arise	14/06/2022
de Cartaret (Huggins)	Emma	Member and Trust Rep - East of England Ambulance Services NHS Trust	Yes		Y		Husband a BT manager	15/09/2019	Ongoing	Does not deal with any NHS contracts or processes	26/09/2022
de Cartaret (Huggins)	Emma	Member and Trust Rep - East of England Ambulance Services NHS Trust	Yes	Y			ICSA student member	01/01/2019	Ongoing	Does not deal with any NHS contracts or processes	26/09/2022
Ekuban	Belinda	Clinical Director, Titan PCN, representing PCN Clinical Directors in Central Bedfordshire, BCA and ICB	Yes	Y			Clinical Director for Titan Primary Care Network	01/07/2021	Ongoing	Exclusion from involvement in related meeting or decision-making	19/10/2022

Surname	Forename	Position within, or relationship with the ICB	Interests to Declare	Type of Interest			Description of Interest	Date From	Date To	Actions to be taken to mitigate risk	Date Declared
				Financial Interest	Non-Financial Professional	Indirect					
Elford	Mary	Cambridgeshire Community Services NHS Trust (HCP member)	Yes	Y		Chair, Cambridgeshire Community Services NHS Trust	01/04/2020	Ongoing	Declare in line with conflicts of interest policy	23/09/2022	
Elford	Mary	Cambridgeshire Community Services NHS Trust (HCP member)	Yes	Y		Trustee and NED of NHS Providers	01/07/2021	Ongoing	Exclusion from involvement in related meeting or decision making	07/12/2022	
Griffiths	Dorothy	Chair, CNWL	Yes	Y		Trustee Imperial College Student Union	Jun-17	Ongoing	Declaration interest, withdraw from discussion as appropriate	10/01/2023	
Head	Vicky	Director of Public Health, Bedford Borough, Central Bedfordshire and Milton Keynes.	No							27/06/2022	
Hussain	Javed										
Jackson	Louise										
Keech	Tracy	Healthwatch MK	Yes	Y		Member of procurement panel for Brooklands, Neath Hill, and Kingfisher GP Practices	Dec-22	25/01/2023	Declare in line with conflicts of interest policy	15/12/2022	
Kocen	Jane	Bedfordshire Care Alliance Member - Clinical Director for Caritas Medical PCN	Yes		Y	My Husband Dr Rory Harvey is a Consultant Gastroenterologist at Bedford Hospital (1999) , he is one of the clinical leads for integration and the clinical lead for general surgery across both hospital sites	Jun-05	Ongoing	Declare in line with conflicts of interest policy	09/12/2022	
Macpherson	Angela	ICP Board member, Deputy Leader, Buckinghamshire Council	No							22/09/2022	
Makarem	Rima	Chair, BLMK ICB	Yes	Y		Chair of Sue Ryder (non remunerated)	01/05/2021	Ongoing	Declare in line with conflicts of interest policy	17/06/2022	
Makarem	Rima	Chair, BLMK ICB	Yes	Y		Chair of Queen Square Enterprises Ltd (remunerated)	01/11/2020	Ongoing	Declare in line with conflicts of interest policy	17/06/2022	
Makarem	Rima	Chair, BLMK ICB	Yes	Y		Lay Member of General Pharmaceutical Council	Apr-19	Ongoing	Declare in line with conflicts of interest policy	17/06/2022	
Malik	Khtija										
Marland	Peter	Leader of a local authority	No			Honorary Associate, The Open University.	Jul-22	Jul-23	Declare interest for any agenda items related to ageing.	07/12/2022	
Mehra	Sonal	VCSE Partnership Lead - funded by ICB but hosted by VCSE organisation	Yes	Y		Delivering talks and writing articles to support the Ageing Well project.				07/12/2022	
Mehra	Sonal	Voluntary, Community & Social Enterprise Partnership Lead	Yes	Y		Director, Catalyst Health Solutions CIC, 18 Station Terrace, Marsh Drive, Great Linford, Milton Keynes MK14 5AP The company offers training and consultancy services to organisations operating in th health, wellbeing and car sector	Feb-21	Ongoing	Remove myself from any decisions regarding commissioning of training or consultancy support	28/09/2022	

Surname	Forename	Position within, or relationship with the ICB	Interests to Declare	Type of Interest			Description of Interest	Date From	Date To	Actions to be taken to mitigate risk	Date Declared
				Financial Interest	Non-Financial Professional	Non-Financial Personal					
Murphy	Mike	Exec Dir of Strategy & Business Development, South Central Ambulance Service	No								26/09/2022
Nicholson	Lucy	Chief Executive, Healthwatch Luton	No								05/10/2022
Ogley	Julie	Central Bedfordshire Council Director of Social Care, Health and Housing	Yes	Y			Aug-20	Ongoing	Exclusion from involvement in related meeting or decision-making		10/08/2022
Rammohan	Navaneetha	Clinical Director, Nexus MK PCN/ICP rep for MK PCNs	Yes	Y			01/02/2018	Ongoing	To be excluded from meeting when discussing primary care issues		26/09/2022
Rammohan	Navaneetha	Clinical Director, Nexus MK PCN/ICP rep for MK PCNs	Yes	Y			01/07/2019	Ongoing	To be excluded from meeting when discussing primary care issues		26/09/2022
Simmons Stock	Hazel Tracey	Chair ICP	Yes			Y	15/12/2021	01/05/2023	None		05/07/2022
Taylor	Eileen	Acting Chair East London NHS Foundation Trust (substantive chair from 1/1/23)	Yes	Y			Acting Chair 01/04/2022 To become substantive Chair 1/1/2023	30/09/2025	As appropriate		08/12/2022
Taylor	Eileen	Acting Chair East London NHS Foundation Trust (substantive chair from 1/1/23)	Yes	Y			Chair Designate North East London NHS Foundation Trust CEME Centre- West Wing Marsh Way Rainham Essex RM13 8GQ	30/09/2025	As appropriate		08/12/2022
Taylor	Eileen	Acting Chair East London NHS Foundation Trust (substantive chair from 1/1/23)	Yes	Y			Non Executive Director MUFU Securities EMEA PLC 25 Ropemaker Street London	Ongoing	As appropriate		08/12/2022
Walker	Kate	Adult Services, Bedford Borough Council	No								11/01/2023



Date: 14/12/2022

Time: 14.00

Venue: MSTeams

Minutes of the: Health and Care Partnership

Members:			
Surname	Forename	Title	Initials
Stock	Tracey	Chair	TS
Barhey	Baz	PCN Clinical Director Luton	BB
Cartwright	Sally	Director of Public Health, Luton	SC
Cox	Felicity	CEO BLMK ICB	FC
Davis	Alison	Chair Milton Keynes Hospital	AD
Elford	Mary	Chair Cambridgeshire Community Services	ME
Ekuban	Belinda	PCN Clinical Director, Central Bedfordshire	BE
Griffiths	Dorothy	Chair CNWL	DG
Hopkins	David	Councillor Milton Keynes Council	DH
Hussain	Javed	Councillor, Luton Borough Council	JH
Jackson	Louise	Chair of the Health and Wellbeing Board, Bedford Borough Council	LJ
Keech	Tracy	Healthwatch Milton Keynes, Deputy CEO	TC
Kocen	Jane	PCN Clinical Director Bedford	JK
Makarem	Rima	Chair BLMK ICB	RM
Malik	Khtija	Public Health and Commissioning Luton Council Portfolio Holder	KM
Mehta	Sonal	BLMK VCSE Lead	SM
Nicholson	Lucy	Healthwatch Luton	LN
Ogley	Julie	Director of Social Care, Health and Housing, Central Bedfordshire Council	JO
Rammohan	Navaneetha	PCN Clinical Director, Milton Keynes	NR
Taylor	Eileen	Acting Chair, East London Foundation Trust	ET
Terry	Helen	CEO, Healthwatch Bedford Borough	HT
Walker	Kate	Director of Adult Services, Bedford Borough Council	KW

In attendance:			
Surname	Forename	Title	Initials
Brierley	Anne	Chief Strategy and Transformation Officer BLMK ICB	AB
Carberry	Chris	Business Development Manager, East of England Ambulance	CC
Chakrabarti	Sanhita	Clinical Lead, BLMK ICB	SC
Coker	Patricia	Central Bedfordshire Council	PC
Poulain	Nicky	Chief Primary Care Officer, BLMK ICB	NP

Stanley	Sarah	Chief Nursing Officer, BLMK ICB	SS
Summers	Michelle	Associate Director Communications & Engagement, BLMK ICB	MS
Turrell	Gill	Head of Quality, BLMK ICB	GT
Wheeler	Deborah	Non-Executive Director, ELFT	DW
Whiteman	Sarah	Chief Medical Director, BLMK ICB	SW
Wogan	Maria	Chief of System Assurance and Corporate Services	MW
Evans-Riches	Michelle	Programme Manager ICS Transition, BLMK ICB	ME-R

Apologies from members:			
Surname	Forename	Title	Initials
De-Carteret	Emma	Director of Corporate Affairs and Performance, East of England Ambulance	ED
Head	Vicky	Director of Public Health Bedford Borough, Central Bedfordshire and Milton Keynes	VH
Hopkinson	Andrew	Chief Fire Officer, Bedfordshire Fire Service	AH
Linnett	Simon	Chair Bedfordshire Hospitals	SL
Simmons	Hazel	Leader, Luton Council	HS
MacPherson	Angela	Leader, Buckinghamshire County Council	AM

2 members of the public also attended

No.	Agenda Item	Action
1.	<p>Welcome, Introductions and Apologies</p> <p>The Chair welcomed everyone to the meeting. Apologies were received and noted as above. The meeting was confirmed as quorate.</p>	
2.	<p>Relevant Persons Disclosure of Interests</p> <p>Members were asked to declare any relevant interests relating to matters on the agenda and there were none declared.</p>	
3.	<p>Approval of Minutes and Matters Arising</p> <p>The minutes of the meeting held on 21 September 2022 were approved as a true record.</p>	
4.	<p>Review of Action Tracker</p> <p>The action tracker was reviewed. It was noted that action 2 Health and Care Partnership Terms of Reference remains open, as it relates to paragraph 8.1 whereby authority could be delegated to the Joint Committee by the Integrated Care Board and this has not occurred or been required to date. To avoid</p>	

	confusion, it was agreed to delete this 'holding section' from the terms of reference until needed. Action	ACTION 4 MER
5	<p>Health and Care Partnership purpose and governance</p> <p>The report stated that the BLMK Health and Care Partnership is a Joint Committee of the Board of the Integrated Care Board (ICB) and the local authorities with responsibility for social care for BLMK residents (Bedford Borough, Central Bedfordshire Luton, Milton Keynes and Buckinghamshire Council) and has a statutory duty to:</p> <p style="padding-left: 40px;">Develop, agree and monitor the implementation of the Health and Care Strategy for Bedfordshire Luton and Milton Keynes, building on Joint Strategic Needs Assessments, Health and Wellbeing strategies, Place plans, and the voice of people with lived experience, to achieve improved population health outcomes and reduced inequalities for people who live in BLMK.</p> <p>The draft BLMK Health and Care Strategy was on the agenda for consideration and discussion.</p> <p>There is a requirement to review the Terms of Reference for the Health and Care Partnership within six months of it being established and then annually. As the Partnership continues to evolve it was felt that the Terms of Reference should remain unchanged with the exception of the removal of paragraph 8 Authority, as no delegation had been made from the Integrated Care Board as yet and the Terms of Reference can be altered if there is delegation in future.</p> <p>Agreed: That paragraph 8 be removed from the Terms of Reference and that the terms of reference be reviewed again in 6 month's time when the Joint Committee will have been operating for one year.</p>	ACTION 5MER
6	<p>Joint Strategic Needs Assessment and Population health</p> <p>Sally Cartwright introduced the report and informed members that each local authority is statutorily required to collaborate with the NHS to produce a Joint Strategic Needs Assessment (JSNA). The JSNA identifies local population health needs and the JSNAs in the four local authority areas are at various stages e.g., Luton has recently refreshed its JSNA.</p> <p>The JSNA's have been examined to identify commonality across BLMK and identified inequalities which will underpin the development of the Health and Care Strategy. It was recognised that public health has an essential role in the development and implementation of the health and care strategy. The inequalities identified are:</p>	

	<p>illness have much lower life expectancy than that of the general population, largely due to a higher prevalence of physical conditions.</p> <p>13. Carers - Carers in BLMK are twice as likely to have a mental health problem and are almost three times more likely to have a long-term condition. It is essential to provide carers with support to prevent a crisis in the NHS and care sector.</p> <p>14. Cost of Living - Fuel poverty in BLMK varies from 7.3% in Milton Keynes to 16.4% in Luton, but it is estimated that 55% of UK households will be experiencing fuel poverty by January 2023, with higher rates among large families, lone parents, and pensioners. This will have an adverse impact on the health and wellbeing of our residents. Local authorities have additional funding which can be provided to families in need.</p> <p>15. Climate change and air pollution - Tackling the key sources of air pollution and carbon emissions will improve health and reduce inequalities.</p> <p>It is important, as partner organisations, that we understand and collectively address the social determinants of health e.g. housing, employment, so that inequalities are not exacerbated when making decisions and planning services.</p> <p>The VCSE has a valuable role both strategically and locally in supporting residents. CNWL had produced a video of how the mental health alliance in Milton Keynes supported local people. ELFT had a community's interest company that advertised grants across BLMK, for example MIND is providing support for people on weighting lists.</p> <p>Agreed: That the report be noted, and the key themes be considered in the development of the Health and Care Strategy.</p>	
7	<p>Place update including Health and Wellbeing Board feedback from recent meetings and local issues</p> <p>The Health and Wellbeing Boards set local strategies to meet the needs of residents in their areas. This informed the system health and care strategy and a summary of the meetings of the Health and Wellbeing Boards for the five local authorities was reported.</p> <p>Bedford Borough has had a recent meeting which had not been included in the report and the following items had been discussed:</p> <ul style="list-style-type: none"> • Cost of living crisis • Warmer homes scheme – which had used data from general practice to inform the scheme. • Cancer Care • Primary care estate – which the executive delivery group is leading on. 	

	<ul style="list-style-type: none"> Update on Invasive Group A streptococcal infection which provided assurance on detection and antibiotic availability to treat infections. <p>Items of note at the Central Bedfordshire HWBB were:</p> <ul style="list-style-type: none"> The physical activity strategy – particularly the initiatives being taken to build strength and balance to help prevent falls. The Fuller neighbourhood programme and estates prioritisation. <p><u>Discussion</u></p> <p>There is a statutory requirement to undertake an access to community pharmacy every three years led by public health and this was reported to the Health and Wellbeing Boards.</p> <p>Access to palliative care medication especially out of hours was raised and there is a multi-disciplinary team working on end-of-life support which includes community pharmacy service provision. The BLMK pharmacy website has details of access to palliative care medication.</p> <p>ACTION: Information on access to palliative care medication will be provided.</p> <p>The government has announced a new independent review into oversight of Integrated Care Systems (ICSs) to reduce disparities and improve health outcomes across the country, following record investment in health and social care. The review which is being led by former Health Secretary the Rt Hon Patricia Hewitt who is currently Chair of NHS Norfolk & Waveney Integrated Care Board, will explore how to empower local leaders to focus on improving outcomes for their populations. The report is due to be published by the end of March 2023 and evidence is being requested for submission by early January 2023.</p> <p>ACTION: The request for evidence for the Hewitt Review be circulated to Partnership members for individual and ICS co-ordinated response.</p> <p>In November 2022, the Government issued non-statutory guidance for Health and Wellbeing Boards on its purpose within the system architecture.</p> <p>ACTION: The guidance for Health and Wellbeing Boards be reported to the next meeting.</p> <p>Agreed: That the issues discussed by the Health and Wellbeing Boards be noted and taken into account in developing the health and care strategy for BLMK.</p>	<p>ACTION 8 NP</p> <p>ACTION 9 MER</p> <p>ACTION 10 HWBB Chairs/MER</p>
8	<p>Integrated Care Board (ICB) update</p> <p>The Board of the ICB had met four times since its inception on 1 July 2022, with the initial meeting being a procedural meeting to approve all the</p>	

	<p>governance documentation required for the new organisation. A summary of the items considered was included in the papers for the meeting. The Chair of the Health and Care Partnership, Tracey Stock, is a participant member of the Board of the ICB to ensure the views of the Partnership are represented.</p> <p>Agreed: That the ICB update report be noted.</p>	
9	<p>Draft BLMK Health and Care Strategy update</p> <p>The Chair introduced the draft BLMK health and care strategy and asked members for comments on:</p> <ul style="list-style-type: none"> A) The content B) The communication style – relevance and accessibility to the public and partners C) The communications approach to publicise and engage residents, local communities and staff with this strategy <p>Anne Brierly presented the draft BLMK health and care strategy that had been included in the papers for the meeting and stated that it was a high-level summary of how the partners across BLMK collaborate to improve the health and wellbeing of our residents. It sets the overall ambition of the ICS of statutory partners working with communities and the VCSE to enable our residents to thrive. This is defined as supporting people to live longer, particularly where there are inequalities in life expectancy, and living more years in good health.</p> <p>The draft BLMK Health and Care Strategy is required to be published by the Health and Care Partnership by the end of December 2022/early January 2023, but it is recognised that the strategy is a living document and will continue to evolve.</p> <p>The importance of focusing on areas of variation in health and wellbeing outcomes at system level by the ICB and through subsidiarity and delivery at Place was emphasised. Health and Wellbeing Boards / Place-Based Boards are key to meeting the local needs of residents and delivery at Place.</p> <p>The Health and Care Partnership does not seek to replicate what our statutory partners are doing but articulates how we need to work together to meet our residents needs.</p> <p>The cost-of-living crisis and the pandemic has shown us that doing more of the same thing is not going to achieve our ambition and the strategy sets the tone and focus of how we are going to work differently. The Health and Wellbeing Boards will be considering this strategy in the new year and will be identifying what can be delivered at Place in the next 1-2 years. The NHS partners in BLMK are developing a 5-year plan to achieve our priorities of Start Well, Live Well and Age Well by addressing inequalities and supporting growth and sustainability.</p>	

Discussion:

- The BLMK VCSE strategy group have been consulted on the draft strategy and comments will be fed back. The VCSE section could be strengthened to reflect the value, expertise and professionalism of the sector and the trusted relationship it has with local communities, particularly those that are seldom heard. The ICB and VCSE has signed a Memorandum of Understanding on how it will work together and the VCSE is recognised as a strategic partner in BLMK..
- The strategy identifies what is possible if we work together. The priorities will emanate from Place plans and the Health and Care Partnership can provide constructive challenge as to whether we are doing enough to address inequalities.
- We are committed to co-design and co-production of services and the example of the emergent Mental Health, Learning Disability and Autism Collaborative was given. The Collaborative will engage with service users by March 2023 to identify what matters to the individuals and this will underpin the services provided by the Collaborative. It will use tools to enable individuals to set their own personal goals.
- There are lots of pockets of good practice and projects across BLMK and oversight is required to ensure there are no gaps in services e.g., Children and Young People.
- There will be variation in service delivery at Place, recognising the differences in Place, the communities and needs. It is important that services are of the same standard and there is equity of access to the services.
- The draft strategy recognised the challenges for BLMK, e.g., access to urgent and emergency care, but it did not reflect what has and is being done.
- There has been a shift in the way the NHS can allocate resources and through the planning process resources can be targeted to where there is variation in access and health outcomes. For example, 1 year cancer survival rates are poorer in Luton, and we need to understand the reasons for this in order to address it.
- We need to examine where we are providing services and the reach of the service. Primary Care Networks and neighbourhoods can provide valuable insight for their local community e.g., in Central Bedfordshire the NHS are being challenged on the levels of dementia diagnosis which are below expected levels.
- Through subsidiarity to Place, Primary Care Networks will have the opportunity to access enabling services and support get things done for their local neighbourhoods.
- The strategy needs to reflect wider partners e.g., police, fire services, and the challenges for all public sector bodies. It needs to reflect the strong established partnerships with other agencies and how we can work collaboratively e.g., one public estate which has input from all local partners. It is recognised that the fire service not only provides

	<p>prevention advice for residents in relation to fire hazards and keeping safe, but also makes safeguarding referrals for vulnerable residents.</p> <ul style="list-style-type: none"> • Some of the language in the draft strategy needs to be amended e.g., use of the term 'lifestyle choices' which infers that people have a choice in how they live, but often that is not the case. • Case studies need to be equitable across BLMK and BM will provide a Learning Disability pilot case study for inclusion. <p>Agreed: 1. That the comments be incorporated into the draft BLMK Health and Care Strategy and the final version circulated to Health and Care Partnership members when published on the Partnership's website.</p> <p>2. That Health and Wellbeing Chairs to present a summary of their Place plan for 2023-4 to the March HCP meeting, with specific focus on how it will deliver the strategy as relevant to their population.</p> <p>3. That case studies and resident feedback on how the strategy has made an impact be brought back to the Health and Care Partnership in six months.</p>	<p>ACTION 11 AB</p> <p>ACTION 12 HWBB Chairs</p> <p>ACTION 13 AB</p>
10	<p>The Fuller Programme – Delivering Integrated Primary Care</p> <p>The final report of the stocktake undertaken by Dr Claire Fuller, on integrated primary care was published in May 2022. It looked at what is working well in Integrated Care Systems, why it is working well and how we can accelerate the implementation of integrated primary care (incorporating general practice, community pharmacy, dentistry and optometry) across systems.</p> <p>The streamlining of same day urgent care is the biggest challenge, and the aim is to provide person-centred approach to patient care for long term conditions e.g., diabetes and meet the needs of patients with complex care. In order to do this effectively, multi-disciplinary neighbourhood teams will be aligned to the local communities. The following are examples from our system of delivering proactive personalised care.</p> <ul style="list-style-type: none"> • Multi-disciplinary team (MDTs) working to support residents of care homes • Multi-disciplinary team working to support the population with Long Term Conditions • Geriatric interface frailty offer from Bedfordshire Hospitals Trust – the silver phone and virtual MDTs • End of Life Care planning • Supporting children with neurological conditions in Luton <p>The report identified that the majority of patients accessed GP surgeries for urgent treatment and there are various methods of access e.g., telephone, on-line consultations, virtual and face to face.</p> <p>Primary Care Network (PCN) Clinical Directors are embedded at Place and PCNs are target specific local needs, taking a population health management approach to make a meaningful difference to residents' lives.</p> <p><u>Discussion</u></p>	

	<ul style="list-style-type: none"> • In response to a question on what additional support could be given to general practice the following points were raised by the PCN Clinical Directors: <ul style="list-style-type: none"> ➢ Expansion of teams has meant that clinical space has been exhausted and there is a need for more. Lack of adequate space impacts on staff morale. ➢ Administrative duties to code and file information could be automated using further system digital solution. saving non-clinical staff time. ➢ Expand clinical teams for example with associate clinical practitioners, this will enable General Practitioners to focus on patients with complex needs and long-term conditions. ➢ Freeing up time to enable innovation and research would make the roles more attractive for recruitment and would help with retention of existing staff. • The model of care is changing from a medical to a psycho/social model with embedded support and services at a local level to meet social and mental health needs. This model of care will support people to stay well and with multi-disciplinary teams, including community voluntary, social enterprise, reaching into communities. • During the pandemic, methods of access to general practice were expanded e.g., virtual appointments, on-line consultations and these were welcomed by patients. However, enabling digital innovation may cause issues for those who are not digitally enabled. • Steps have been made by practices to make it easier for patients to cancel appointments to reduce the number of missed appointments. • A review of our deep-end practices in areas of the highest deprivation has been undertaken. One of the aspects being examined is access to services when your first language is not English. This often prevents patients accessing services in a timely manner. • It is recognised that there has been a great deal of innovation and improvement in general practice in the last 10 years and the resident view is that the general practitioner and not the wider members of the PC team as the only gateway to ongoing care. • Healthwatch receive a lot of communication regarding concerns with access to a dentist. It was explained that there is a national contract for dentistry which does not financially recompense dentist's work, especially in areas of deprivation, and therefore, a proportion of dentists have become private providers only. Within Luton, it is estimated that one in 5 children have tooth decay, and teams are working with schools on educating children to clean their teeth properly with supervised sessions and the impact of this initiative will be measured. The commissioning for dentistry will be delegated from NHSE to the ICB in April 2023. ACTION: An update on dentistry will be brought to the next meeting. • Local authorities know their local communities and have a role to play in communicating information to residents. The ICB communications has worked with partners to provide a bulletin for each of the four Places in BLMK on how to access primary care. ACTION: Local Authorities be requested to support the onward communication of the primary care bulletin to local communities. <p>Agreed: That the report on the progress of the Fuller Programme be noted.</p>	<p>ACTION 14 NP</p> <p>ACTION 15 HWBB Chairs</p>
--	---	--

	<p><u>Mary Elford and Khtija Malik joined the meeting at 4.11pm.</u></p>	
<p>11</p>	<p>Communications from the meeting</p> <p>Key communications from the meeting are:</p> <ol style="list-style-type: none"> 1. Health and Care Partnership (H&CP) purpose and governance – the H&CP Terms of reference were reviewed, and it was decided that there were no material changes, and these would be reviewed at 12 months. 2. Joint Strategic Needs Assessment and Population Health – a presentation was given by the Sally Cartwright, the Director of Public Health for Luton on the population health information for our diverse community in BLMK. The presentation included 15 facts about health inequalities in BLMK which included the wider determinants of health e.g., deprivation, ethnicity, smoking, obesity, cost of living, air pollution etc. It highlighted the difference in life expectancy and healthy outcomes in deprived areas compared to more affluent areas and how residents’ health and wellbeing can be affected by more than one inequality e.g., areas of deprivation tend to be more built up and air quality is often poorer. 3. The value of Health and Wellbeing Boards in providing valuable knowledge and insight on the needs of local communities and what is being done locally to address the needs was recognised. There is new guidance regarding Health and Wellbeing Boards, and this will be reported to the next H&CP. 4. Draft Health and Care Strategy – The Partnership has a statutory duty to develop, agree and monitor a health and care strategy for BLMK which builds on the Joint Strategic Needs Assessments, Health and Wellbeing Strategies and local Place based plans. The draft strategy was presented and provides a high-level summary of how we are going to collaborate across BLMK, Place and neighbourhood to meet the needs of our communities. The role of the VCSE as a strategic partner to the statutory organisations was emphasised and will be strengthened in the draft strategy. The complexity of bringing together plans and programmes e.g., children & young people was a challenge, but it was important to have oversight and to learn from good practice. 5. Integrated Primary Care update – the Fuller Review (next steps for integrating primary care) was published in May 2022 and emphasised the importance of integrating primary care at neighbourhood level. Primary care includes clinical services at general practice, community pharmacy, optometry and dental services. Access to general practice was a key issue for residents and it was acknowledged that there were now different ways to access the services e.g., face to face, on-line and telephone consultations. Despite embracing the new ways of working, demand for appointments in general practice outstripped the provision and the meeting discussed workforce, estates, administrative issues that could potentially free-up more clinical time. <p>The importance of communicating with residents’ issues being faced by general practice and how local elected Councillors can help inform residents was agreed.</p> <p>NHS England are delegating responsibility for community pharmacy, optometry and dental services to ICBs from April 2023. Given resident</p>	

	<p>feedback on difficulties accessing dental care a report will be made to a future meeting.</p>	
9	<p>Health and Care Partnership Forward Plan</p> <p>Items from the meeting which will be added to the forward plan for the next meeting:</p> <ul style="list-style-type: none"> • Health and Care Strategy • Joint Forward Plan – The ICB agreed plan to realise the strategy. • Dentistry • Community Engagement • Health and Wellbeing Board guidance • Report from HWBBs • Report from ICB <p>Items for a future meeting:</p> <ul style="list-style-type: none"> • VCSE sector summary of activities in BLMK and actions taken on the ICB and VCSE Memorandum of Understanding • Health and Care Strategy – feedback from the community on impact 	
10	<p>Any Other Business</p> <p>RM said that the Health and Care Partnership is responsible for developing, agreeing and monitoring the health and care strategy and the importance for members to own the aims and ambition of the strategy, particularly reflecting it in their own organisations.</p> <p>CCS Strategy Development</p> <p>ME reported that Cambridgeshire Community Services Board development day had discussed their three-year plan that is informed and aligned to the health and care strategy. It will focus on prevention, supporting people to keep in good health, evidence innovation and partnership working and how we work differently to maximise the benefit to our residents and maximise value for money.</p> <p>Self-referral to Smoking Cessation and Weight Management Services</p> <p>JK stated that smoking and weight management had been identified in the population health report as a whole system issue. It would be beneficial for residents to be able to self-refer into support services, rather than requiring a clinical referral. This could then be communicated widely to make it easy for people to seek support. ACTION: Directors of Public Health investigate the feasibility of self-referrals for smoking cessation and weight management.</p> <p>Housing Growth</p>	<p>ACTION 16: SC/VH</p>

	<p>JH raised that BLMK has extensive housing growth planned and assurance was sought that infrastructure support was integral to planned developments. It was confirmed that there is close working between local authority and NHS on estates and the growing population is a key element of the discussions. The use of s.106 contributions for infrastructure is discussed between the local authorities and local partners.</p> <p>AD stated that transport provision to ensure access to services e.g., to diagnostic hubs, needs to be carefully considered.</p> <p>Noted</p>	
11	<p>Date and time of next meeting</p> <ul style="list-style-type: none"> ▪ 7 March 2023 5-8pm ▪ Room 1.02, Milton Keynes Council, Civic Offices, 1 Saxon Gate East, Milton Keynes, MK9 3EJ <p>Deadline for papers will be: 23 February 2023</p>	

The meeting ended at 16.34

Approval of Draft Minutes by Chair only:		
Name	Role	Date
Tracey Stock	Chair of BLMK Health and Care Partnership	16.01.2023

Meeting of the Health and Care Partnership - Action Tracker

Key

Escalated	Escalated - items flagged RED for 3 subsequent meetings - BLACK
Outstanding	Outstanding - no actions made to progress OR actions made but not on track to deliver
In Progress	In Progress - actions made to progress & on track to deliver due date -
Not Yet Due	Not Yet Due
COMPLETE:	COMPLETE - GREEN
Propose closure at next meeting	Propose closure at next meeting
CLOSED	CLOSED
(dd/mm/yyyy)	

Items to be moved to "closed actions" once closed

Action No.	Meeting Date	Item Title	Action	Responsible Manager (Enter full name)	Past deadlines (Since Revised)	Current Deadline	Current Position	RAG (Add date action is agreed closed)
4	14/12/2022	Action tracker	Paragraph 8.1 to be removed from the Terms of Reference as it causes confusion	Michelle Evans-Riches		27/01/2023	Revised TOR approved by ICB Board on 27 January 2022	COMPLETE: Propose closure at next meeting Not Yet Due
5	14/12/2022	Health & Care Partnership Purpose and Governance	Terms of Reference be reviewed in six months time	Michelle Evans-Riches		22/06/2023		
6	14/12/2022	Joint Strategic Needs Assessment and Population Health	Clarification on the mental health and behaviour cause of death as detailed in the report will be provided.	Sally Cartwright		30/01/2023		
7	14/12/2022	Joint Strategic Needs Assessment and Population Health	There is a dedicated immunisation catch up programme across BLMK and more detail on this would be provided to members.	Nicky Poulain		30/01/2023	Information circulated	COMPLETE: Propose closure at next meeting
8	14/12/2022	Place Update	Information on access to palliative care medication will be provided.	Nicky Poulain		30/01/2023	Information circulated	COMPLETE: Propose closure at next meeting
9	14/12/2022	Place Update	The request for evidence for the Hewitt Review be circulated to Partnership members for individual and ICS co-ordinated response.	Michelle Evans-Riches		09/01/2023	Request for evidence was circulated to Partnership members and none was received.	COMPLETE: Propose closure at next meeting
10	14/12/2022	Place Update	The guidance for Health and Wellbeing Boards be reported to the next meeting.	HWBB Chairs/Michelle Evans-Riches		17/03/2022	See item 7 on agenda	
11	14/12/2022	Draft Health & Care Strategy	Comments be incorporated into the draft BLMK Health and Care Strategy and the final version circulated to Health and Care Partnership members when published on the Partnership's website.	Anne Brierley		30/12/2022	Comments incorporated and Health and Care Strategy published and link circulated to Partnership members	COMPLETE: Propose closure at next meeting
12	14/12/2022	Draft Health & Care Strategy	Health and Wellbeing Chairs to present a summary of their place plan for 2023-4 to the March HCP meeting, with specific focus on how it will deliver the strategy as relevant to their population.	HWBB Chairs		17/03/2022	On agenda item 7	
13	14/12/2022	Draft Health & Care Strategy	That case studies and resident feedback on how the strategy has made an impact be brought back to the Health and Care Partnership in six months.	Anne Brierley		22/06/2023		Not Yet Due
14	14/12/2022	The Fuller Programme – Delivering Integrated Primary Care	An update on dentistry will be brought to the next meeting.	Nicky Poulain		17/03/2023	Incorporated in a position statement on Optometry. Community Pharmacy and Dentistry delegation of services. Item 8	

Action No.	Meeting Date	Item Title	Action	Responsible Manager (Enter full name)	Past deadlines (Since Revised)	Current Deadline	Current Position	RAG (Add date action is agreed closed)
15	14/12/2022	The Fuller Programme – Delivering Integrated Primary Care	Local Authorities be requested to support the onward communication of the primary care bulletin to local communities.	HWBB Chairs		17/03/2023		
16	14/12/2022	AOB	Directors of Public Health investigate the feasibility of self-referrals for smoking cessation and weight management.	Sally Cartwright/Vicky Head		17/03/2023	Self referral for smoking cessation and weight management already in place for Bedford Borough, Central Bedfordshire and Milton Keynes	

Report to BLMK Integrated Health & Care Partnership Board
7 March 2023

Item 6 Proposed Approach: BLMK ICB Joint Forward Plan

Vision: “For everyone in our towns, villages and communities to live a longer, healthier life”

Please state which strategic priority and / or enabler this report relates to

Strategic priorities

<input checked="" type="checkbox"/>	Start Well: Every child has a strong, healthy start to life: from maternal health, through the first thousand days to reaching adulthood.
<input checked="" type="checkbox"/>	Live Well: People are supported to engage with and manage their health and wellbeing.
<input checked="" type="checkbox"/>	Age Well: People age well, with proactive interventions to stay healthy, independent and active as long as possible.
<input checked="" type="checkbox"/>	Growth: We work together to help build the economy and support sustainable growth.
<input checked="" type="checkbox"/>	Reducing Inequalities: In everything we do we promote equalities in the health and wellbeing of our population.

Enablers

Data and Digital <input checked="" type="checkbox"/>	Workforce <input checked="" type="checkbox"/>	Ways of working <input checked="" type="checkbox"/>	Estates <input checked="" type="checkbox"/>
Communications <input checked="" type="checkbox"/>	Finance <input checked="" type="checkbox"/>	Operational and Clinical Excellence <input checked="" type="checkbox"/>	Governance and Compliance <input checked="" type="checkbox"/>
Other <input type="checkbox"/> (please advise):			

Report Author	Hilary Tovey, Interim Director of Strategy, ICB Vicky Head, Director of Public Health, Bedford, Central Bedfordshire and Milton Keynes Borough Councils
Date to which the information this report is based on was accurate	1 st March 2023
Senior Responsible Owner	Anne Brierley Chief Transformation Officer, BLMK ICB

The following individuals were consulted and involved in the development of this report:

BLMK Integrated Care Board Members

This report has been presented to the following board/committee/group:

The Joint Forward Plan is our partnership long term plan to deliver the outcomes of the BLMK Integrated Health and Care Partnership Board Strategy, which was approved at the BLMK Health & Care Partnership Board on 14th December 2022

Purpose of this report - what are members being asked to do?

The members are asked to:

1. Is this the right approach to building the Joint Forward Plan for Places in BLMK?
2. Are there key issues that are missing?
3. How will we undertake this co-production with local residents at Place?
4. What role will Health & Well-being Boards play in overseeing development of Place Joint Forward Plans?
5. Are there issues we should agree a common approach / local delivery to maximise impact and affordability?

Executive Summary Report

This paper sets out the proposed approach to the development of the BLMK ICS Joint Forward Plan. This is an NHSE requirement, spanning a minimum of 5 years and covering both

- partnership / collaborative plans at Place to deliver the 4 core requirements of the ICB
- medium-term plan for NHS to deliver the Operating Plan requirements across all domains of healthcare (primary care, urgent & emergency care, cancer, children and young people's services, diagnostics and elective recovery, mental health & learning disabilities)

In essence, this is the medium-long term joint plan for ICB partners to deliver the improvement in health outcomes and reduced inequalities as well as NHS Constitutional Standards at each Place, as identified in existing Place Plans – to make real the ambitions for our residents set out in our Strategy.

The ambitions of our ICB exceed this minimum specification, and the purpose of this briefing is to test with members whether the proposed approach outlined in this presentation is the right one to best deliver our Strategy for our residents. Specifically, the proposed approach is:

- to develop the Joint Forward Plan in BLMK for a long-term period (15-20 years). This reflects the rapid expansion in the population of BLMK to 2040 and beyond, and the changing demographic in each Borough over this period
- to focus the Plan on the shared 'wicked' issues to improve health outcomes and tackle inequalities in local communities where only a collaborative and innovative approach can meet rising population need and demand within workforce and affordability constraints
- to focus on the wider determinants of health and well-being, maximising prevention and enabling community assets (including the voluntary sector) to enable our communities to thrive
- to include chapters which specifically outline;
 - how NHS-specific plans will underpin our strategic ambition and meet NHS constitutional standards
 - where a collective approach to infrastructure (digital, estates and capital) and shared resources (workforce) can better deliver the greatest benefit to our local residents

In short, our approach to developing the Joint Forward Plan is to focus on our people rather than our existing service lines.

A draft of our Plan (the plan for the Plan) is due for approval at the March ICB Board (24th March) for submission to NHS England thereafter; and the first iteration of the Plan to be submitted to NHS England by 30th June 2023.

It is proposed that the June submission captures the key actions, gives clear actions and timelines where this is known, and a shared methodology and timeline for development and implementation over years 1-3 of the Plan. Over time, the Plan will host the Gantt chart of the critical milestones of where 'tipping points' in population growth and need at Place will require a new approach to be implemented to support reducing inequalities, sustain access to health services, and bring together our sovereign responsibilities to enable our communities to thrive.

1. Brief background / introduction:

The ICS' Strategy is owned by the Integrated Health & Care Partnership, who act as 'custodians for population health', supporting and enabling improvements to health outcomes and tackling inequalities as outlined in the strategy.

The strategy aims to:

- Reflect our 5 strategic priorities (Start Well, Live Well, Age Well, Growth and Tackling Inequalities)
- Include commitment to subsidiarity (to place), with a focus on planning, decision-making and delivery as close to the resident as possible
- Emphasize our ambition to go further using our partnerships to support residents to live longer, and live more years in good health, and the central role played by VCSE in supporting residents to thrive
- Speaks to real examples that make a difference to local people

The minimum requirements for the ICB Joint Forward Plan are centred on 3 principles:

- **Principle 1:** the plan is aligned with the ambitions of the wider system partnership.
- **Principle 2:** the plan supports subsidiarity, building on existing local strategies (including Joint Strategic Needs Assessments and Health and Wellbeing strategies) and reflect universal NHS commitments.
- **Principle 3:** the plan is delivery-focused, including specific objectives and milestones as appropriate.

The minimum legislative requirements for content are:

- Link to ICB Mandate, Integrated Care Strategy, Joint strategic needs assessments, Joint local health and wellbeing strategies and system capital plans
 - Plans for system governance, financial duties and efficiencies
 - An integrated workforce plan
 - Action to reduce inequalities, promote personalised care, research and innovation, and deliver a net zero NHS
 - Our approach to integration and addressing the triple aim
 - Specifically, how we plan to address the need of **children and young people** and **victims of abuse**

ICBs must involve Health and Well-Being Boards as follows in the development and approval of the Joint Forward Plan:

- joint forward plans for the ICB and its partner NHS trusts and NHS foundation trusts must set out any steps that the ICB proposes to take to implement any JLHWS
- ICBs and their partner NHS trusts and NHS foundation trusts must involve each relevant HWB in preparing or revising their forward plans
- in particular, the HWB must be provided with a draft of the forward plan, and the ICB must consult with the HWB on whether the draft takes proper account of each relevant JLHWS
- following consultation, any HWB within the ICB's area has the right to respond to the ICB and may give its opinion to NHS England
- within the ICB's forward plan, it must include a statement from the HWB as to whether the JLHWS has been taken proper account of within the forward plan

- with the establishment of ICBs and the abolishment of CCGs, the former requirement for CCGs to share their commissioning plans with HWBs is now removed

2. Options to Deliver

The minimum and proposed options to develop and deliver the Joint forward Plan are summarised above, and covered in detail on the attached presentation

3. Key Risks and Issues

Key risks are:

- Whilst housing plans are clearly defined for each BLMK Borough, the projected population growth, demographic shift, and consequent impact on tackling inequalities and improving health outcomes are not clearly plotted over the next 15-20 years. Without this, the Joint Forward Plan will not be able provide assurance as to whether the proposed Plan will deliver our strategic objectives for all BLMK residents
- Options that are deliverable and affordable to address any gaps in the Plan may be limited

Have you recorded the risk/s on the Risk Management system?

[Click to access system](#)

Yes

No

Defined risks, mitigations, controls and residual unmitigated risks will be specified as the Plan is developed, and added to the ICB Board Assurance Framework for ongoing oversight.

4. Are there any financial implications or other resourcing implications, including workforce?

Financial and workforce implications will be picked up through the development of the Plan

5. How will / does this work help to address the Green Plan Commitments?

[Click to view Green Plan](#)

This is a clearly defined priority in the Plan

6. How will / does this work help to address inequalities?

This is a clearly defined priority in the Plan

7. Next steps:

The next steps are outlined in the Executive Summary above.

8. Appendices

None

9. Background reading

- BLMK system strategy
- BLMK summary strategy
- [NHS England Operational Planning guidance 23/24](#)
- [NHS England guidance on developing Joint Forward Plans](#)

Our Joint Forward Plan Proposed Approach



Integrated Health and Care Strategy

- Our Integrated Health and Care Strategy sets out an overarching ambition to: **increase the number of years** people spend **in good health** and **reduce the gap** between the **healthiest and least healthy** in our community.

The strategy aims to:

- Reflect our five strategic priorities (Start Well, Live Well, Age Well, Growth and Tackling Inequalities)
- Include commitment to subsidiarity (to Place), with a focus on planning, decision-making and delivery as close to the resident as possible
- Emphasise our ambition to go further using our partnerships to support residents to live longer, and live more years in good health, and the central role played by VCSE partners in supporting residents to thrive
- Speak to real examples that make a difference to local people

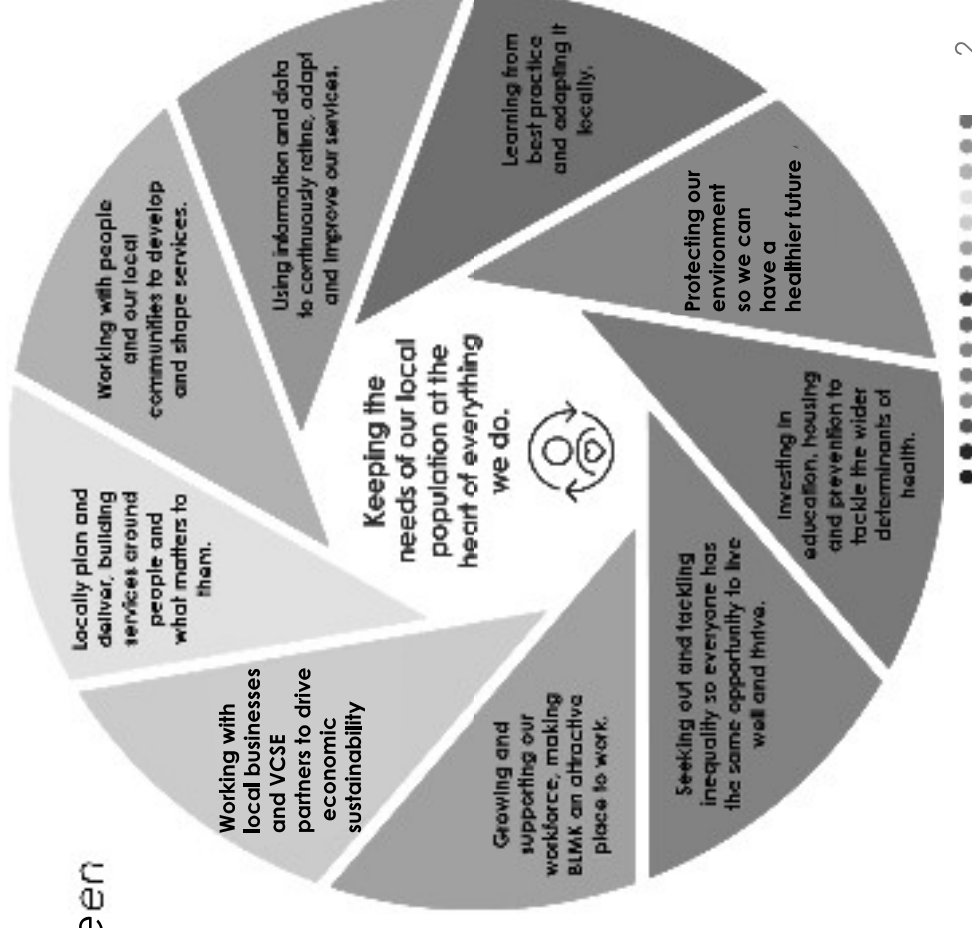

Joint Forward Plan: Content

Guidance on the development of the Joint Forward Plans sets out three principles:

- **Principle 1:** the plan is aligned with the ambitions of the wider system partnership.
- **Principle 2:** the plan supports subsidiarity, building on existing local strategies (including Joint Strategic Needs Assessments and Health and Wellbeing strategies) and reflect universal NHS commitments.
- **Principle 3:** the plan is delivery-focused, including specific objectives and milestones as appropriate.

Legislative requirements (must do's)

- Link to Mandate, Integrated Care Strategy, Joint strategic needs assessments, Joint local health and wellbeing strategies and system capital plans
- Plans for system governance, financial duties and efficiencies
- An integrated workforce plan
- Action to reduce inequalities, promote personalised care, research and innovation, and deliver a net zero NHS
- Our approach to integration and addressing the triple aim
- Specifically how we plan to address the need of **children and young people** and **victims of abuse**



Other recommended content

- Performance
- Digital / data
- Estates
- Procurement / supply chain
- Population Health Management
- System development
- Supporting wider social and economic development

Joint Forward Plan

All systems are required to publish a five-year Joint Forward Plan, to be updated annually. The JFP is expected to outline medium term plans for health and care to support delivery of the system strategy.

The first draft of this plan is required by 31st March with a final version submitted to NHS England on the 30th June 2023.

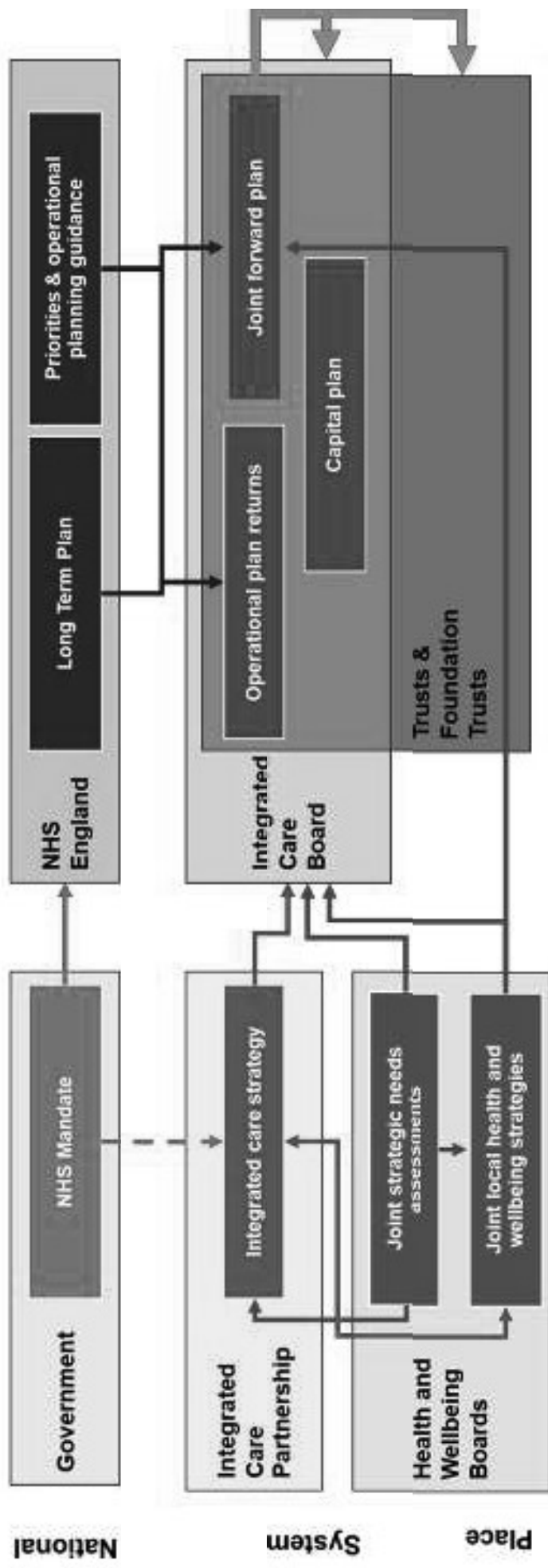

increasing the number of years people spend in good health and reducing the gap between the healthiest and least healthy in our community.

By 2040



Newborn...

7...

16...

30...

65...

80...

Start Well

Live Well

Age Well

Tackle Inequalities

Growth & Sustainability

In 2023

in utero

13 years old

48 years old

63 years old

Key Questions

- Where can we achieve more through Partnership to deliver our Strategic aims?
- Where do we need a radical approach to delivering more of the same?
- What are our opportunities to collaborate and innovate to meet growth and demand within public resources?

Our Joint Forward Plan Delivered at Place

What are the Challenges we need to address?

Universal Offer

- Population growth in BLMK
- Changing needs of population
- Cost of living, inflation, affordability of increased services
- Workforce & infrastructure capacity
- Tackling inequalities (specific populations at Place)
- Improving health outcomes (prevention, early diagnosis & treatment, secondary prevention)
- Supporting communities to thrive – education, employment, housing, leisure
- Sustainability & environment

Most disadvantaged populations

- Looked after Children / multiple adverse childhood experiences
- Young offenders / prison population
- Families living in chronic deprivation (long-term unemployment / poor housing / debt)
- Carers
- People with severe & enduring mental illness / learning disabilities
- People experiencing violence, coercion and abuse

Place priorities

Bedford Borough

- Understanding our communities
- Promoting prevention and health promotion
- Transforming care with primary care and the VCSE

Central Bedfordshire

- Improving access and supporting healthy choices
- Supporting independence for older people
- Tackling inequalities and wider health determinants

Luton

- Giving every child the best start in life
- Sustainable communities and tackling inequalities
- Reducing frailty and supporting independence

Milton Keynes

- Children and young people's mental health
- Tackling obesity
- Reducing avoidable hospital admissions
- Supporting people with complex needs



Our Joint Forward Plan

The strategic actions to deliver our Place Plans



1) Understand how our population will change over next 15 years



Population change of selected local authority areas in the East of England between 2011 and 2021

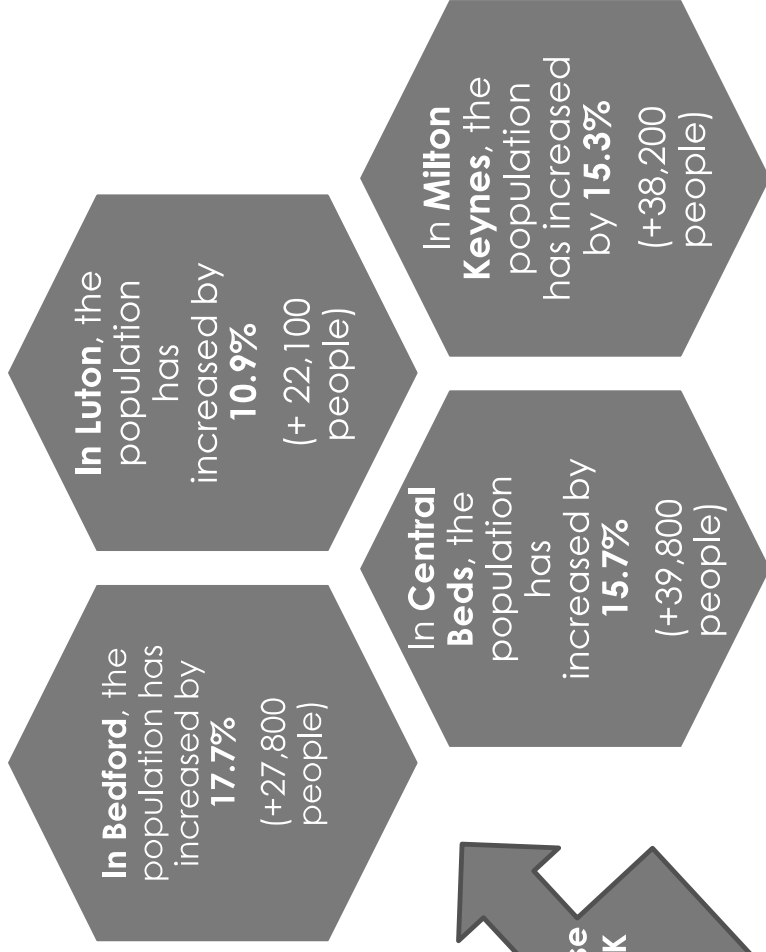
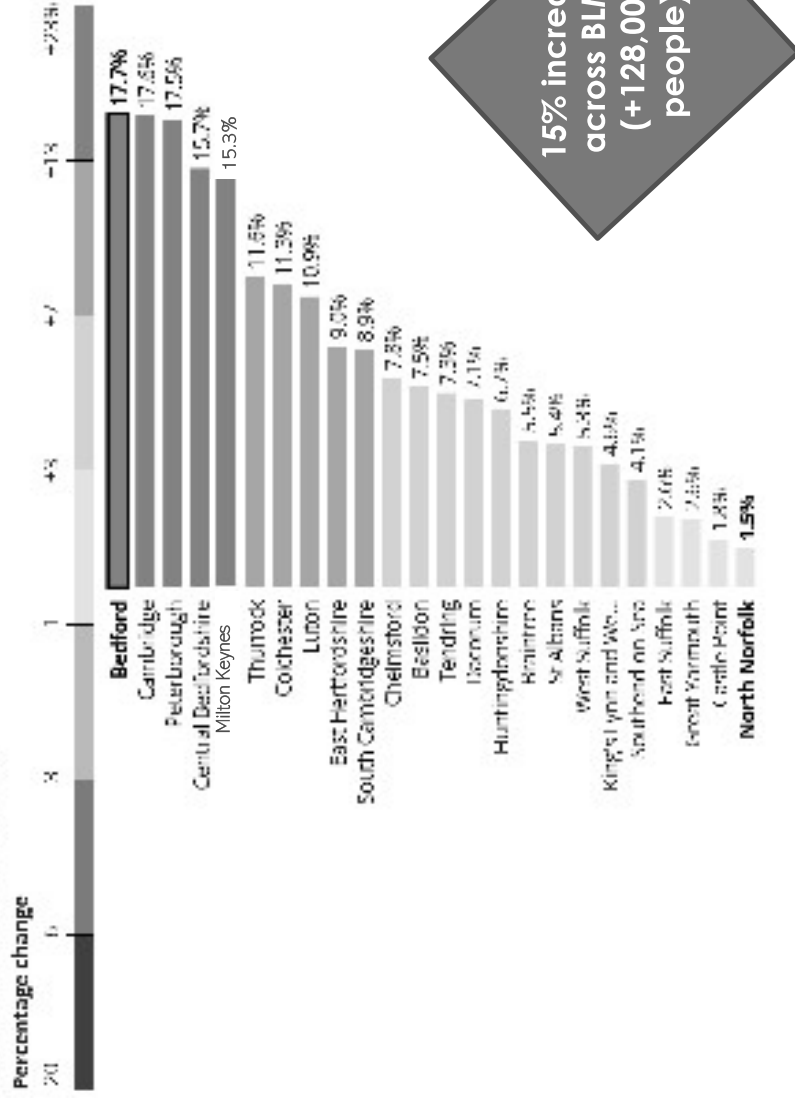

Population Growth in BLMK



- Over the last ~10 years, roughly 5,000 homes completed per year across BLMK (CBC > MK > BBC > Luton)
- Local Plans / housing strategies suggest around 6,000 new homes across BLMK per year in coming years

• New homes drive growth in young families:

- School place planning
- Primary care, paediatrics, maternity
- Influenced by housing mix (sizes of properties and tenure)
- NB can be specific provision of homes for older people

- *National (ONS) population projections consistent with +2,400 homes per year – gap of 3,600 new homes per annum in BLMK*

BLMK: Age structure of people who changed address in previous year (2011)

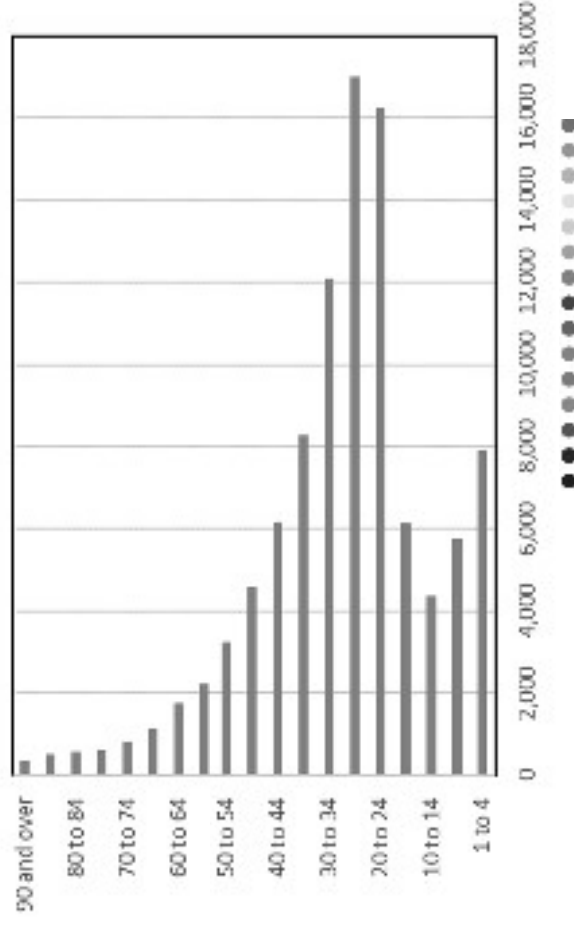

Growth in older people

- ONS projections less reliable for >65s
- 2021-2031:
 - 17% increase in 65-74s
 - 33% increase in 75+
- Major driver of health & care utilisation

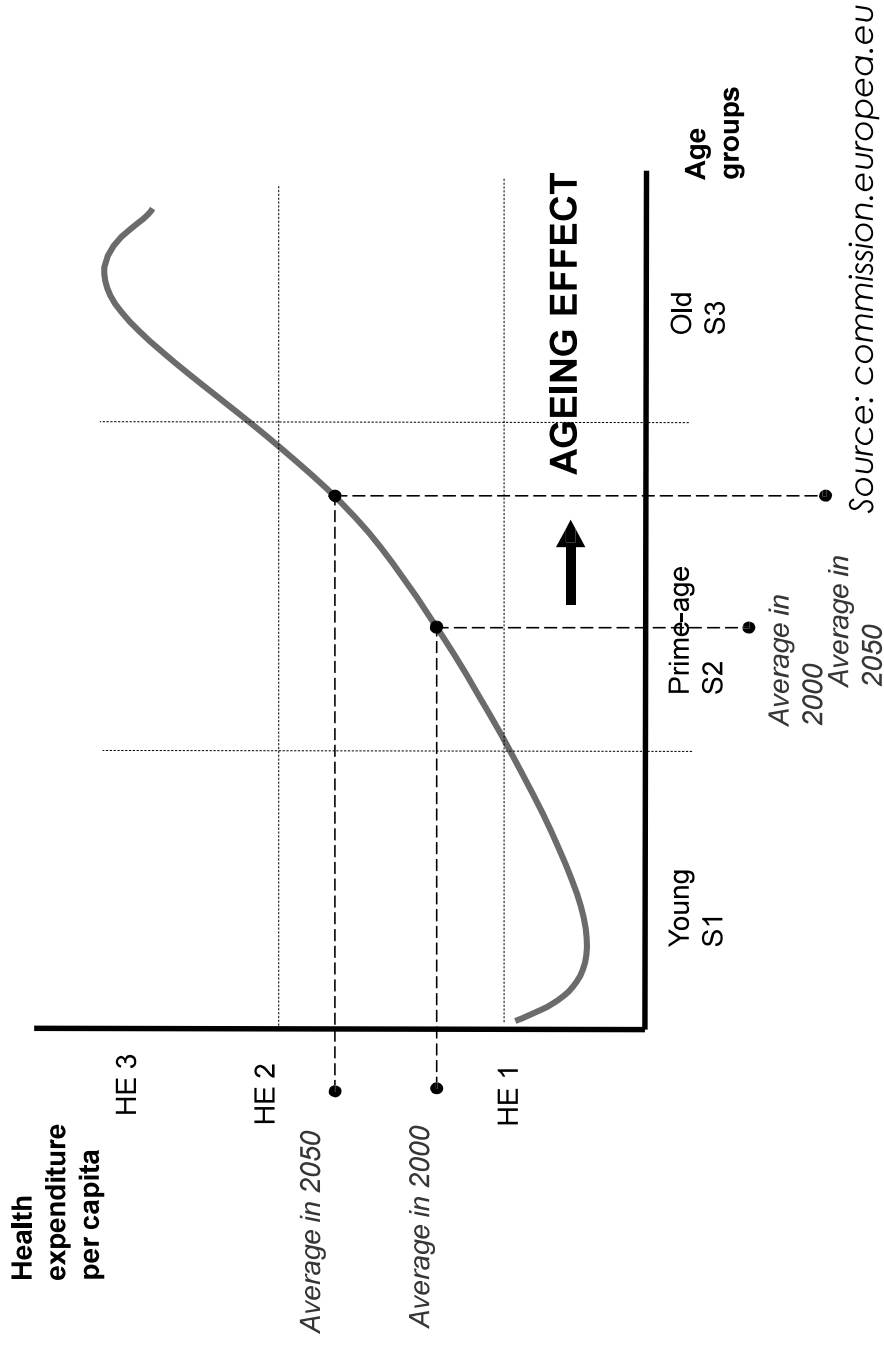

Non-demographic growth in expenditure



- There are important non-demographic drivers that have generated further upward pressures on health spending.

What is non-demographic growth?

- Increasing expectation and demand for healthcare services
- Improving access to care
- Changes in health care technology
- Medical practice
- Public and policy expectations
- Quality
- Changes in disease profile, etc

(NHS Five Year Forward View)

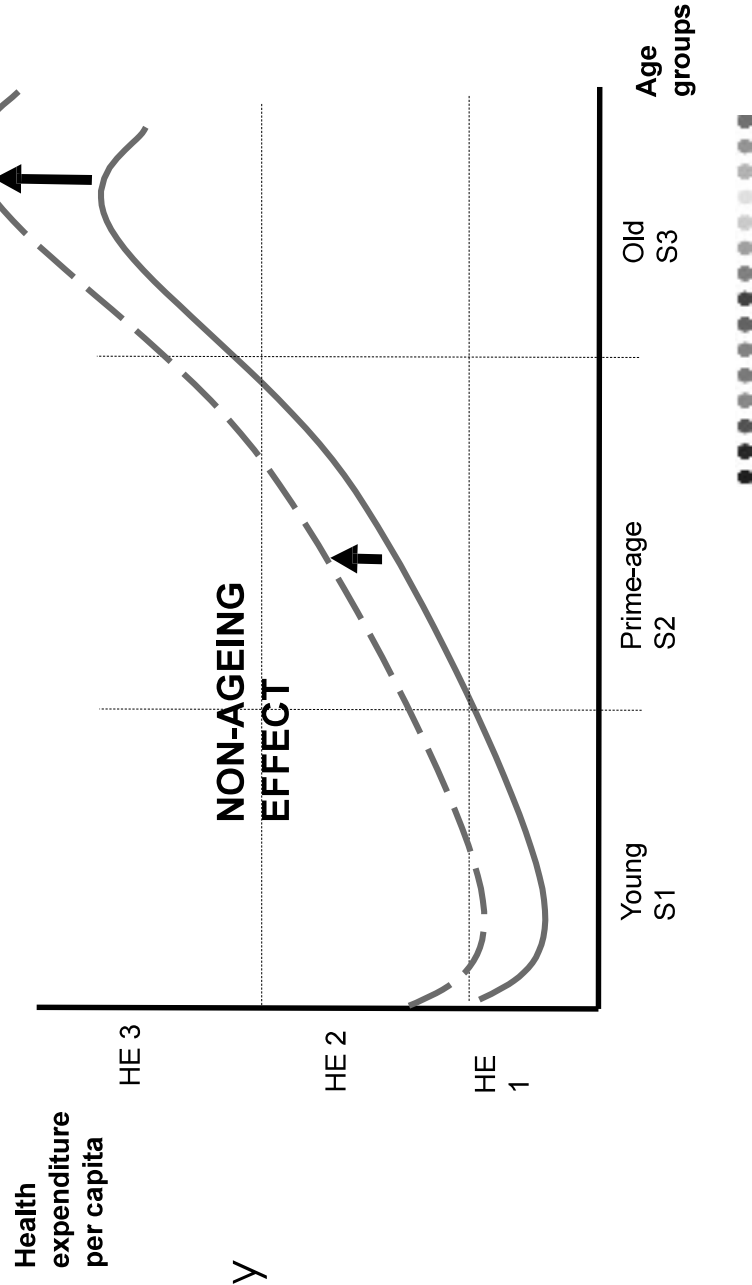

2) Understand need & demand

Maslow's hierarchy of needs



What is the service you need?

OR

What is the need you want to address?

Are we treating symptoms or tackling root causes?

**Co-produce
within
communities**

3) Enable our communities to thrive

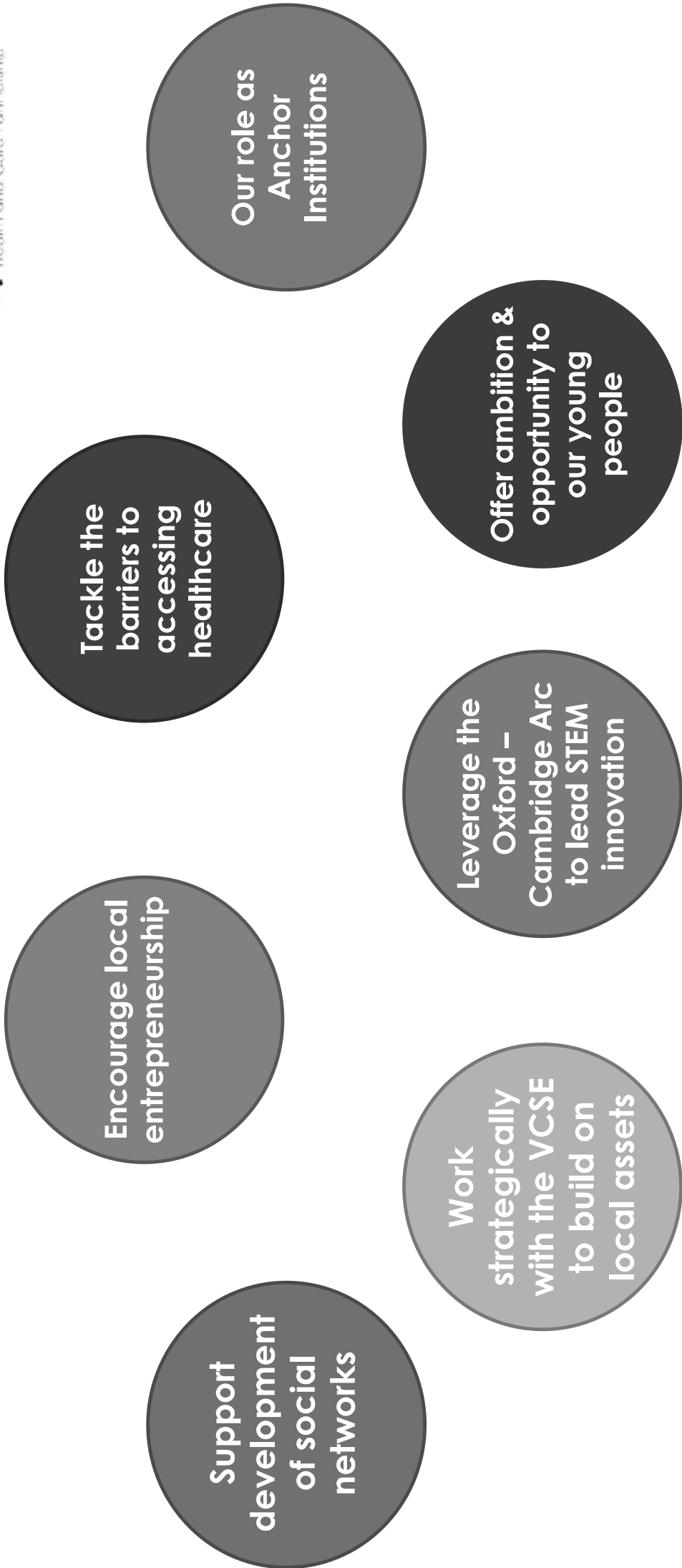

4) Understand how we can adapt our services to better support our communities

Fuller
Neighbourhoods
to meet
population
growth

Use digital
technology

Remove the
cultural barriers
to access

Provide
services in
spaces local
communities
already use

5) Understand where we can further leverage improvements to inequalities through partnership



Build on the learning from the Denny Review

Bring together our intelligence on population need to inform proactive early interventions

Leverage our research capabilities

Pool public health interventions resources, and co-ordinate approaches across Partners

Build on resourcing and utilising the reach of the VCSE and partner public sector organisations

No-one left behind



6) Understand how we can adapt our offer to better support people with the highest needs to thrive



Newborn...

7...

16...

30...

65...

80...

What is our offer to our children with the highest / most complex needs?

How can we enable people with learning disabilities to live their best lives?

How do we offer early support / adaptations to people who are neuro-

What are the recovery pathways and placements for people with severe and enduring mental illness?

How can we reduce loneliness and isolation for older people?

7) Tackle unwarranted variation in health – access & outcomes

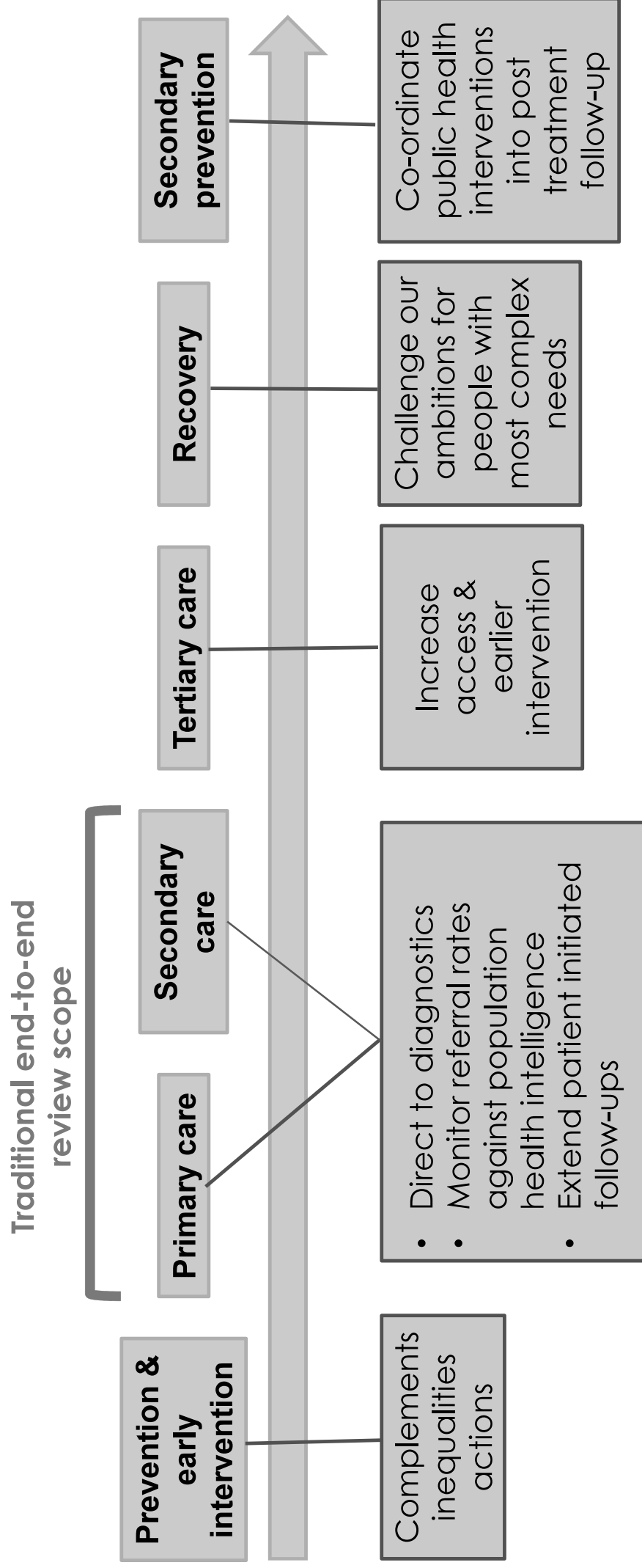

8) Get upstream to better influence outcomes



For example:

Prevention offer at Neighbourhood / local community / whole public sector / VCSE

Peri-natal care

Use all public sector resource for key prevention – e.g. falls

Offer speech & language therapy & autism spectrum disorder support earlier to young children

Educating & mentoring for first time offenders

Maximise public health impact – every contact counts

9) Jointly plan our infrastructure & capacity to meet demand



Grow and offer training for our entry-level staff across NHS, LA, VCSE and wider public sector

Deliver services in spaces communities already use

Grow our digital access & use technology to liberate workforce capacity

Plan our joint capital developments aligned to expected population growth – be radical how we use our estate



Building the Joint Forward Plan: During 2023-4, we will...

- Develop the growth / needs map for Places in BLMK looking ahead to 2040**
- Agree at Place where we will adapt / collaborate / be radical to address our 'wicked issues' for our communities & deliver Place Plans**
- Co-produce solutions with local communities to improve health access and outcomes, and utilise own assets to thrive**
- No-one left behind: our joint plan at Place covers universal offer AND targeted actions to address inequalities**
- Understand the remaining gaps between need / demand / affordability**

- Bring together population intelligence and metrics to assess reach and impact of our joint endeavours**
- Understand the opportunities of estate (public & privately owned)**
- Agree methodology & schedule for end-to-end review of clinical pathways**
- Agree NHS contribution to growth & sustainability at Place**
- Map estates assets & high public use areas at Place**

Our Joint Forward Plan will...



Set out the road-map, AND the emerging collaborative actions based on Place Plans to 2040:

Enable our communities to thrive – building own assets to meet local needs



Have evidence-based messaging to influence & lobby national policy & local research & innovation

Innovate & collaborate to meet changing need & demand for local communities

Our Joint Forward Plan

Questions for the BLMK Health & Care Partnership Board

Check-in: our Next Steps?

1. Is this the right approach to building the Joint Forward Plan for Places in BLMK?
2. Are there key issues that are missing?
3. How will we undertake this co-production with local residents at Place?
4. What role will Health & Well-being Boards play in overseeing development of Place Joint Forward Plans?
5. Are there issues we should agree a common approach / local delivery to maximise impact / affordability?

Joint Forward Plan: Timeline

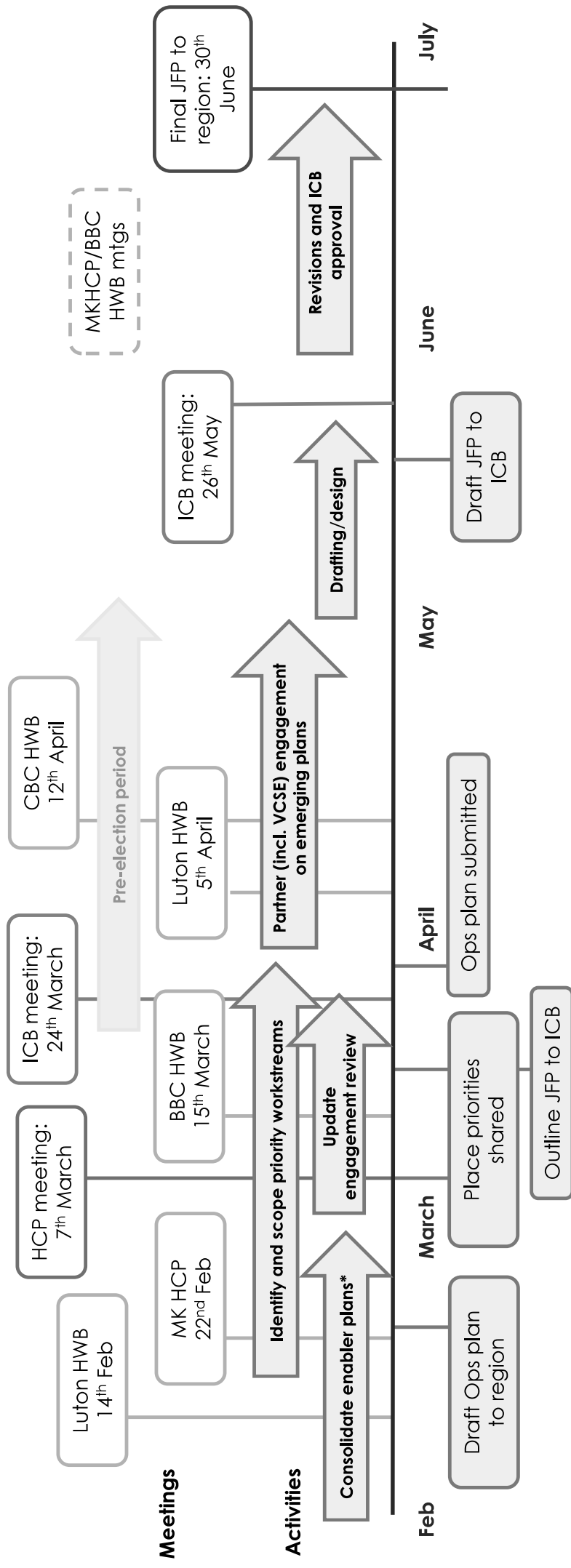

*enabler plans include estates, finance, growth and sustainability, inequalities, personalisation, co-production, digital and data and working with people and communities

**Report to the Health and Care Partnership
7 March 2023**

Item 7 Place Plans, Health and Wellbeing Board Updates and guidance for Health and Wellbeing Boards and Integrated Care Partnerships

Vision: "For everyone in our towns, villages and communities to live a longer, healthier life"

Please state which strategic priority and / or enabler this report relates to

Strategic priorities

- | | |
|--------------------------|--|
| <input type="checkbox"/> | Start Well: Every child has a strong, healthy start to life: from maternal health, through the first thousand days to reaching adulthood. |
| <input type="checkbox"/> | Live Well: People are supported to engage with and manage their health and wellbeing. |
| <input type="checkbox"/> | Age Well: People age well, with proactive interventions to stay healthy, independent and active as long as possible. |
| <input type="checkbox"/> | Growth: We work together to help build the economy and support sustainable growth. |
| <input type="checkbox"/> | Reducing Inequalities: In everything we do we promote equalities in the health and wellbeing of our population. |

Enablers

Data and Digital <input type="checkbox"/>	Workforce <input type="checkbox"/>	Ways of working <input type="checkbox"/>	Estates <input type="checkbox"/>
Communications <input type="checkbox"/>	Finance <input type="checkbox"/>	Operational and Clinical Excellence <input type="checkbox"/>	Governance and Compliance <input checked="" type="checkbox"/>
Other <input type="checkbox"/> (please advise):			

Report Author	Michelle Evans-Riches, Programme Manager ICB Transition
Date to which the information this report is based on was accurate	24 February 2023
Senior Responsible Owner	Maria Wogan, Chief of Chief of System Assurance and Corporate Services

The following individuals were consulted and involved in the development of this report:

ICB Place Link Directors
Health and Wellbeing Board secretariat

This report has been presented to the following board/committee/group:

Not applicable

Purpose of this report - what are members being asked to do?

The members are asked to **note** the following:

- A) The Place Plans for Bedford Borough, Central Bedfordshire, Luton and Milton Keynes.
- B) The reports from the Health and Wellbeing Boards.
- C) The implications of the Health and Wellbeing Board guidance issued on 22 November 2022 and agree to take action as appropriate at place.

Executive Summary Report

1. Brief background / introduction:

1.1. Place Plans

Each of the four Places in BLMK have been developing Place plans, identifying local priorities that partners can work collectively on to improve the health and wellbeing of local residents.

Bedford Borough

Bedford Borough's vision is to thrive as a place that people are proud of, want to live in and move to. Local plans recognise a growing and strong local economy and an active response to climate change as two important factors in achieving this. From this foundation residents will be able to thrive and realise their potential, supporting and celebrating Bedford Borough's diverse and inclusive communities.

The Bedford Borough place plan has been developed by the Health and Wellbeing Board and commits to:

- Understanding our communities
- Promoting prevention and health promotion
- Transforming care with primary care and VCSE

Central Bedfordshire

The Central Bedfordshire Place Plan was agreed at the Health & Wellbeing Board and outlines the ambitions for Central Bedfordshire to 2025 (see Appendix A). The Plan has three over-arching ambitions set out below:

- **Promoting fairness and social inclusion** – by identifying and tackling underlying inequalities in social and wider determinants of health, to give everyone the best opportunity to live a healthy life and promote better, equitable access to services, across community, acute and primary care.
- **Living Well** – everyone should have the right and opportunity to live their best life, with the required support and infrastructure to make healthy choices and maximise wellbeing.
- **Ageing well** – continue to provide support and services required to meet the needs of our aging population, while adapting to changing demands and new models of care, through both the formal service offer and supporting and developing community based services.

Measures of success have been identified for each of the priorities and progress will be monitored by the Health and Wellbeing Board.

Luton

By 2040, the vision is for Luton to be a healthy, fair and sustainable town, where everyone can thrive and no-one has to live in poverty, supported by:

- A town built on fairness – tackling inequality
- A child friendly town – investing in young people
- A carbon neutral town – addressing the impact of climate change

The Luton Place Board has developed a place plan which commits to:

- Giving every child the best start in life
- Sustainable communities, and tackling inequalities
- Reducing frailty and supporting independence

Luton At Place Board Update:

- The Luton Place Board membership has expanded iteratively over the last year, ensuring we have the right people around the table including the six PCN clinical directors for the collective agenda. Specialist partners are invited when tabling specific agenda items.
- The Board works in connectivity with the Fuller Report and Marmot Town recommendations, both reports are central to the Boards programme of work. In addition the Board works in tandem with dependent Boards; the Inequalities Board & the Children's Trust Board. Whole system collaboration is central to the working ethos, including our critical relationships with the Voluntary and Community Sector. Members are currently working to strengthen connectivity with the Fire Service & exploring new collaborative opportunities.
- The Strategic approach, objectives and priorities, are supported by an integrated programme of work. Members are currently working with LBC Business Intelligence team towards a dashboard of measures which will evidence the impact of the individual priorities and workstreams. The dashboard will consist of a core group of high-level measures, sitting above a more expansive set of measures for deep-dives into impact and issues arising in specific workstreams, ensuring the workstreams are on track to achieving the ambitions of the Board.
- In 2022 Board members signed a Memorandum of Understanding and a Mutual Accountability Framework, setting out members commitment to One Voice – One Luton and working collectively as one team towards the agreed strategic ambitions and priorities. A review of the approach is currently underway, with the aim to establish a 'Luton Deal'. Further updates will be provided once the work is ready to be tabled.
- A key workstream's under the spot light at the moment are:
 - the Community Hubs, currently in the planning & development phase to support Priority 3 – Empowering Local People to become resilient increasing people's sense of control to manage their own health and wellbeing. The workstream interconnects with the Luton Family Hubs, the Warm Spaces Charter, the Healthy Places Framework, the principles of 'A place to go, a place to talk, a place to do', the Fuller Recommendations & Neighbourhood teams & Luton Core20Plus5. Further updates can be provided as the planning phase progresses.
 - the BLMK Mental Health Provider Collaborative presented an update to members in January and reflected on key opportunities across the footprint, in particular in response to the Fuller Recommendations. The update provided a platform for informative discussions around interconnectivity at Place level, the draft Luton Mental Health Strategy and the mental health workstream, Priority 1 of the Place Board programme; Early intervention and Prevention Services tackling the cause of poor health and wellbeing. The draft Luton Mental Health Strategy is currently being socialised and following due governance process, with an action plan in development.
 - the Digital workstream in Priority 3; Empowering Local People to become resilient increasing people's sense of control to manage their own health and wellbeing, is a preventative workstream supporting care provider connectivity with health services and enabling effective care within the community. The Digital Programme, tabled in January, holds a number of collaborative projects across the BLMK footprint, with the Luton Place Board programme holding a sub workstream for Luton. A new ICB funded AI project, Miicare, has gone live, with Luton delivering the first stage roll out. Miicare is a digital tool to support families, carers, and care agencies, who care for vulnerable adults within their own

homes (not care homes). The digital offer ensures that the person within their care can remain in their own home, safely and for as long as possible, whilst providing insights into behaviours that are able to inform proactive care and support when required, and prevent admissions or increase in care package provision.

- the Voluntary Sector Alliance, has been established & presented to the Board in February, with a focus on how voluntary organisations can link in with partners, strengthen relationships and work collaboratively as one team on the Place Priorities and workstreams. Partnerships with the VCS are essential to the Place Board strategic approach and the programme of work. VCS are valued members and contributors to the Board.

Milton Keynes

The Milton Keynes Health and Care Partnership, which has the statutory functions of the Health and Wellbeing Board and also functions as the Place Board, has agreed with the BLMK Integrated Care Board the MK Deal. It formalises the commitment of the main local NHS partners in MK and the City Council to work more closely together. The priorities in the MK Deal are:

- **Improving system flow** – with a focus on urgent and emergency care services for older and/or frail and/or complex service users.
- **Tackling Obesity** - which is focused on helping people lose weight and maintain a healthy weight through easily accessible weight management programmes, use of technology, pharmacological therapies and education/prevention work.
- **Children & Young People’s Mental Health** – recognising that good mental health in children and young people helps build resilience, develop healthy relationships and lays the foundation for better mental and physical health and wellbeing throughout their whole lives. Early intervention is key for lifelong wellbeing: 75% of adult mental health issues are present by the age of 24.
- **Complex Care** - is focused on the improving the planning, assessment, commissioning, and case management for people who have the most complex needs (work stream not initiated yet).

Key metrics have been agreed for the three workstreams that have been initiated and progress is reported to the MK Health and Care Partnership Meetings.

1.2 Updates from Health and Wellbeing Board Meetings

1.2.1 Buckinghamshire Council 15 December 2022 meeting:

- the System Winter Plan helps partners manage the increase in urgent and emergency care over October to March. There is support through the [111 service](#) including advice on Strep A
- The Director of Public Health presented this year’s annual report on preventing cardiovascular disease, which includes heart disease and stroke and what needs to be done to address it. The board agreed the recommendations. [Read the full report](#)
- An Integrated Care Strategy to address the needs of the people and communities of Buckinghamshire, Oxfordshire and Berkshire West has been developed collaboratively and was discussed with the board. Initial priorities have been proposed and a period of public engagement will run to end of January 2023. You can [have your say online](#)
- We signed off the Better Care Fund - Adult Social Care Discharge Fund to support the discharge of patients from hospital over the Winter period.

1.2.2 Central Bedfordshire Health and Wellbeing Board 18 January 2023

- The Board noted that the initial Health and Care Strategy had been agreed last month at the Integrated Care Partnership meeting and it had been published on the BLMK ICB website
- National pressures of the result of covid, flu and Strep A were highlighted to the Board.

- The Board, Members of the Council and Health Colleagues discussed the Integrated Health and Care Hubs and the insufficient capital funds to fund the hubs. There was hope that a collaboration of partners could see the continuation of the Hubs. The ICBs response was that all stakeholders would be receiving a briefing to prevent any further confusion surrounding them.
- The Director of Public Health presented this year's annual report on excess weight and the ambitions in place to address it. The Board agreed the recommendations.
- The final version of the Place Plan was shared with the Board. The intention would be for the Place Plan to be the delivery model of the Health and Wellbeing Strategy.
- The Board received a presentation on the Leisure Facilities Strategy in Houghton Regis. This covered the strategy's overarching aims to provide new, protect existing, and enhance existing facilities as well as the new leisure centre due to open in Houghton Regis in 18 months to 2 years' time.

1.2.3 Luton 14 February 2022

- ICB Public Health reported on an application by Lloyds Pharmacy Ltd to close their branch at Bramingham Park Sainsbury's, Quantock Rise and consolidate services at their branch in Marsh Farm Shopping Centre, Luton, which HWB commented on
- Public Health reported on the draft Luton Tobacco Control Strategy 2023-2028 and received feedback from the HWB for consideration in finalising the strategy. An update on progress was requested in due course
- The Chief Primary Care Officer and the Head of Cancer Network of the BLMK ICB reported on the work being undertaken to improve prevention and early cancer diagnosis in Luton, which was noted and supported by the HWB. An update on the review of Mount Vernon Cancer Centre services, including some of the challenges facing the services and Luton patients was also provided and noted by the HWB
- Public Health gave an update on the Luton Sexual Health Needs Assessment commissioned by Luton Council, Public Health and its NHS partners, which HWB commented on and approved
- A joint report of Luton Council's Corporate Director, Population Wellbeing and the ICB's Chief Primary Care Officer on the Better Care Fund 2023-2024 was presented to the HWB for oversight and to ask for approval of the 2023-2024 allocations for the Better Care Fund and the Improved Better Care Fund, which was given.
- The Luton Director of Public Health gave a presentation on the refresh of the Luton Population Wellbeing draft strategy for discussion and comments. The strategy was well received, particularly the short version and different format in which it was presented. The Strategy refresh will strengthen further the direction of work across the place board and the other sub boards. An update on progress was requested in 6 months' time.
- A joint report of Luton DASS and the ICB Chief Primary Care Officer provided the HWB with an oversight of the Adult Social Care Hospital Discharge Grant, the agreed allocations and the Deed of Variation to be added to the Luton S75 Agreement. HWB ratified the approval of the allocations of the grant and the Deed of Variation given by the Chair outside the meeting due to the tight submission deadline to Government in December 2022
- HWB agreed to receive an update report at its next meeting on 5 April 2023.

1.2.4 Milton Keynes Health and Care Partnership 22 February 2022

- The Partnership received a report from the Director of Public Health on the stop smoking service and agreed actions to reduce smoking prevalence as partners
- The Director of Public Health presented her report on tackling excess weight in MK and the partnership had an extensive discussion on the topic and how all partners could support actions on this agenda, the ambitions in the report were endorsed.
- The ICP and ICB report was received, including noting the BLMK Health and Care Strategy and the next steps in planning and other updates on ICB work programmes including the VCSE Memorandum of Understanding, the Health Impacts of the Green Plan and the planned procurement of Musculoskeletal Services

- The Partnership review progress with the MK Deal and agreed that the priority on Children and Young People's Mental Health should 'go live' on 1 April. The fourth priority on complex care was still being developed and would be considered at the next meeting of the Partnership
- The proposal to pilot locality/neighbourhood working in one or two areas in MK was supported and the Joint Leadership Team was asked to develop this workstream as a potential fifth priority for the MK Deal for the next Partnership meeting.

Bedford Borough Health and Wellbeing Board 15 March 2023

Bedford Borough Health and Wellbeing Board is taking place on 15 March 2023. Papers for the meeting had not been published when this agenda went to print.

There is a meeting with the Health and Wellbeing Board and Health and Care Partnership secretariat to share information.

1.3 Health and Wellbeing Board guidance 22 November 2022

Non-statutory Health and Wellbeing Board (HWB) guidance was published in November 2022, following a consultation on draft guidance in July and August 2022. [Health and wellbeing boards – guidance - GOV.UK \(www.gov.uk\)](https://www.gov.uk/guidance/health-and-wellbeing-boards-guidance)

The guidance document is designed to support Integrated Care Board (ICB) and Integrated Care Partnership leaders (in BLMK this is the Health and Care Partnership), local authorities and HWBs to understand how they should work together to ensure an effective system and place-based working.

The Health and Care Act 2022 did not change the statutory duties of Health and Wellbeing Boards as set out by the Health and Social Care Act 2012. It places an expectation that all place-based arrangements will build on and work with existing forums such as HWBs as key existing place-based forums for driving integration.

The following is a summary of key points from the guidance:

Role and purpose of HWBs

- Membership to include member of ICB and should be reviewed following the establishment of ICBs and ICPs
- Joint Local Health and Wellbeing Strategies (JLHWS) should directly inform joint commissioning, co-ordination of NHS and LA commissioning, including Better Care Fund (signing off plan and providing governance for fund)
- HWBs remain a committee of the local authority to provide a forum to improve health and wellbeing of local population and look to reduce health inequalities
- Deliver Joint Strategic Needs Assessment (JSNA) and JLHWS
- Can be the forum for discussion about strategic and operational co-ordination of commissioned services
- Pharmaceutical Needs Assessment (PNA) remains a requirement for HWBs.

JLHWS and JSNA

- Local authorities, ICBs and NHS England must have regard to these where relevant to exercising their functions
- In developing JSNAs, HWBs should involve communities and representative organisations and consider broader issues e.g. disadvantage, vulnerable groups, wider impacts
- HWBs should consider where there is a lack of evidence and identify research needs which could be met by ICBs, LAs and NHS England as they research (for Local authorities relates to health of children and any other health functions)
- Must consider if the JLHWS needs refreshing when receive the Integrated Care Strategy from the ICP – **action for Health and Wellbeing Boards**
- HWBs should be 'active participants' in the development of the IC Strategy.

- Integrated Care Strategy should build on JLHWSs and identify where needs could be better met at system level; and should identify learning from across the system to drive innovation and improvement.
- JSNAs should be digitised and accessibility improved for a range of users.

Changes

- HWBs, ICBs, ICPs and other place-based partnerships work together to determine the integrated approach to delivering streamlined care and prevention work, including action on wider determinants (building on local work).
- Local authorities and ICBs to jointly establish an ICP (statutory joint committee). In BLMK this is the Health and Care Partnership.

All partners HWBs, ICBs and ICPs to adopt a set of principles in developing relationships, including:

- building from the bottom up
- following the principles of subsidiarity
- having clear governance, with clarity at all times on which statutory duties are being discharged
- ensuring that leadership is collaborative
- avoiding duplication of existing governance mechanisms
- being led by a focus on population health and health inequalities

These principles are not currently in the Health and Care Partnership Terms of Reference (TOR), but will be included when the TOR are next reviewed.

Care Quality Commission (CQC) inspections of Integrated Care Systems will assess provision of NHS care, Public Health and Adult Social Care within the area including:

- How well the ICB, Local authority and CQC-registered providers discharge their care functions
- How the system works as a whole, including the role of the ICP.
- The CQC is required to publish a report, providing an independent assessment of the health and care in integrated care systems

Integrated care strategy:

- HWBs are required to consider revising their JLHWS following the development of the integrated care strategy for their area, but are not required to make changes.
- Expectation that HWBs and ICPs work collaboratively and iteratively in the preparation of the system-wide integrated care strategy.
- ICPs to ensure collective input to their strategic priorities, and that sufficient time is provided for this.
- ICPs should use the insight and data held by HWBs in developing the integrated care strategy.

The Health and Care Strategy was agreed by the Health and Care Partnership in December 2022 and was informed by the Health and Wellbeing strategies and Place priorities. The strategy can be found [BLMK ICP Strategy \(blmkhealthandcarepartnership.org\)](https://blmkhealthandcarepartnership.org)

ICB:

- The ICB has a duty to share with HWB's the ICB and NHS Trust and Foundation Trusts their joint capital resource plan outlining their planned capital resource use. This will provide an opportunity to align local priorities and provide consistency with strategic aims and plans. **Action: ICB once capital resource plan is agreed.**

Before the start of each financial year, an ICB and its NHS partners must prepare a joint forward plan (5-year):

- Must set out any steps on how the ICB proposes to implement any JLHWS
- The HWB must be involved in the preparation or revision of plans and provided with a draft and asked whether it takes account of the JLHWS
- The HWB has a right to respond to the ICB and may share its opinion with NHS England
- The plan must include a statement from the HWB about whether the JLHWS has been taken into proper account
- ICB must consult each relevant HWB as part of their annual review
- NHS England must consult each relevant HWB for their views on the ICB's contribution to the delivery of the JLHWS.

The Joint Forward Plan is being built from Place Plans and the Health and Wellbeing Boards (Place Boards) are being involved in the development of it.

Opportunities

- The Local Government Association has revised its support offer to HWB chairs and other lead members focusing on the implications of integrated care systems

2. Summary of key points:

- 2.1 The four Places in BLMK, Bedford Borough, Central Bedfordshire, Luton and Milton Keynes have been developing and agreeing the local priorities to work collectively on. Each Place is at different stages of developing action plans for each of the priority areas identified to improve the health and wellbeing of their local residents.
- 2.2 A summary of discussion from the Health and Wellbeing Boards of Buckinghamshire, Central Bedfordshire, Luton and Milton Keynes is included in the report. Bedford Borough Health and Wellbeing Board is not meeting until 15 March and a summary of discussion will be presented to the next meeting.
- 2.3 The Health and Wellbeing Board non statutory guidance was published on 22 November 2022. [Health and wellbeing boards – guidance - GOV.UK \(www.gov.uk\)](https://www.gov.uk/guidance/health-and-wellbeing-boards-guidance). It highlights the new ways of working including that of the ICB and Health and Wellbeing Boards with requirements to consult HWB on the Integrated Care Strategy and share ICB and NHS Trust joint capital plans providing an opportunity to align local strategic aims and plans.

3. Are there any options?

Not applicable

4. Key Risks and Issues

None identified as a result of this report.

Have you recorded the risk/s on the Risk Management system?

[Click to access system](#)

Yes

No

5. Are there any financial implications or other resourcing implications, including workforce?

None

6. How will / does this work help to address the Green Plan Commitments?

[Click to view Green Plan](#)

None
7. How will / does this work help to address inequalities?
Place plan priorities aim to tackle inequalities in the local area.
8. Next steps:
Health and Wellbeing Boards to consider the implications of the guidance.
9. Appendices
Appendix A – Central Bedfordshire Place Plan
10. Background reading
None



Central Bedfordshire Place Plan

Update for Health & Care Partnership – March 2023

The Central Bedfordshire Place Plan was agreed at the Health & Wellbeing Board and outlines the ambitions for Central Bedfordshire to 2025. The Plan has three over-arching ambitions set out below.

Promoting fairness and community inclusion

We want to identify and tackle the underlying inequalities in the social and wider determinants of health, to give everyone the best opportunity to live a healthy life and promote better, equitable access to services, across community, acute and primary care.



We will measure success through:

- ✓ Access to housing and homelessness
- ✓ Child and family poverty measures
- ✓ Life expectancy gaps
- ✓ Community engagement measures – access to green space and health and care facilities, infrastructure for walking/cycling
- ✓ Equity in access to healthcare for specific population groups
- ✓ Ability to self manage through adequate information
- ✓ Employment/economic independence measures

Living Well

Everyone should have the right and opportunity to live their best life, with the required support and infrastructure to make healthy choices and maximise wellbeing.



We will measure success through:

- ✓ Educational attainment and reduction in attainment gap
- ✓ Wellbeing and resilience in young people including estimates of life satisfaction, happiness and anxiety
- ✓ Improved mental health and wellbeing, including reducing the gap in premature mortality for people with severe mental illness
- ✓ Population-level measures for smoking, healthy weight, physical activity and alcohol related admissions
- ✓ Uptake of the seasonal flu and covid vaccination
- ✓ Integrated support for long term conditions e.g. early diagnosis and management of diabetes, hypertension and dementia
- ✓ Improved cancer survival rates and reduced premature mortality from cancer

Ageing Well

The Ageing Well priority seeks to ensure that we continue to provide the support and services required to meet the needs of our ageing population, while adapting to changing demands and models of care, through both the formal service offer and through supporting and developing community based services.



Given the breadth of the ambition, the board has identified 5 initial priorities of focus, alongside the ambitions set out within the Director of Public Health's report on Excess Weight. Each of the priorities have a responsible officer(s) who are outlining what success looks like, action already underway and what more is required to deliver the desired outcomes in Central Bedfordshire.

The 5 priorities are:

- 1. Cancer** – prevention, early detection and reducing premature mortality.
 - Experience of care is seamless from primary to tertiary care.
 - Care is brought closer to home with local access to screening in a time that suits a wide range of people and targets areas with lower uptake of screening.
 - Promoting healthy lifestyles
- 2. Children and Young People's Mental Health** – delivering the ambitions to promote positive mental health and wellbeing set out in the Children and Young People's Plan by:
 - Increasing early intervention and prevention by strengthening community offer
 - Increasing Mental Health Support for schools' teams
 - Expanding support for young people with eating disorders
- 3. Mental Health, Learning Disability and Autism** –
 - Experience of care is seamless.
 - Access to help in crises is available in alternative settings to acute hospitals.
 - Reducing the stigma around mental health
 - Improving physical health and wellbeing of people with SMI or LD through health checks and screening programmes
 - Raising awareness of dementia and benefits of early diagnosis

4. Primary Care Access, including dentistry –

- Develop the Central Bedfordshire Fuller Plan for integrated primary care – using the four pillars as a framework to deliver from – 1. Neighbourhood Teams 2. Same day primary care access 3. Proactive and Personalised Care and 4. Prevention
- Continue to develop the one team approach for Central Bedfordshire with primary care and all stakeholders through the roll out and ramp up of the Working Together programme.
- Continue to develop the new models of care centred around the population of Dunstable (utilising Grove View) for Children and Young Peoples Mental Health, Frailty and CVD – and consider and scope opportunities to scale across Central Bedfordshire
- Use a data driven approach to inform co production in meeting residents’ expectations regarding access to primary care appointments and services (GP and dentistry)

5. Intermediate Care Services -

- Develop a ‘one team’ approach that builds on the work already underway to ensure more joined up and timely care for people in a neighbourhood.
 - Use population health data to identify those who are moderately frail and need support to prevent further deterioration – proactive care.
 - Continue to develop the Integrated Health and Care Hub Programme to bring care closer to home.
 - Improve dementia diagnosis.
 - Implement a more robust programme for prevention of falls.
 - Reduce social isolation.
 - Expand the role of the voluntary sector in supporting people in their communities.
-



**Bedfordshire, Luton
and Milton Keynes**
Integrated Care Board

Transferring responsibility for Pharmacy, Optometry and Dental (POD) contracting from NHS England to the ICB

Item 8 BLMK Health and Care Partnership
7 March 2023

Community Pharmacy, Optometry and Dental services in BLMK

- Across BLMK, providing NHS services, there are:
 - 162 Community Pharmacies
 - 86 Optometrists
 - 148 Dental (including 2 acute hospitals and 2 specialist community dental) service providers
- There are also 93 GP contracts that transferred to the ICB on 1 July 2022
- That's 489 contracts in total transferring to the ICB from NHSE from 1st April 2023

Context - what is changing

Current arrangements

- NHS England manage Community Pharmacy, Optometry and Dental service contracts
- Nationally negotiated contracts
- Regional team manages them
- There is no local commissioning decision making and little opportunity to influence



From April 2023

- Responsibility will be delegated to ICBs to enable local system integration
- The contracts will continue to be nationally negotiated but be managed by ICBs
- We will be more able to influence provision to meet local need at place using flexibility within the contracts
- The regional NHS England teams will transfer to ICBs for continuity

How we've been preparing

- Working in partnership with the NHSE Regional Team for the last 12 months to understand all the processes that will change or remain the same
- Completion and approval of a Pre-Delegation Assessment Framework which set out the requirements
- Working through a Safe Delegation Checklist process which is updated monthly to make sure we have everything in place – this is two way to provide NHSE and the ICB with assurance
- Regular updates to our Board and relevant committees in the run up to sign off in March 2023
- Building relationships with local stakeholders including providers, representative committees and HealthWatch to understand local picture

What's the impact for local people in BLMK?

We can target initiatives where we will get best effect for our communities

We can plan a more joined up approach to prevention and early detection of ill health

We can prioritise local inequalities and public health priorities

Plan better pathways across Primary and Secondary care

Better joint working with providers locally putting the patient at the centre

Opportunity to engage with “place” developments e.g. neighbourhood teams

The ICB will use the budgets to meet local priorities

Any visible change will not happen immediately

Integrating Primary Care through the BLMK Fuller Programme



Bedfordshire, Luton
and Milton Keynes
Integrated Care Board



Develop neighbourhood teams aligned to local communities



Streamlined and flexible access for people who require same day urgent care



Proactive personalised care for people with complex needs and co-morbidities



An ambitious, joined up approach to prevention

- Based on the priorities set out in the Fuller report which was named after the author, Dr Claire Fuller and published in May 2022
- The BLMK programme has been developed to localise targeted workplans across the four priority areas set out.
- Link to the Fuller report - <https://www.england.nhs.uk/wp-content/uploads/2022/05/next-steps-for-integrating-primary-care-fuller-stocktake-report.pdf>

How the Fuller Programme links to Pharmacy, Dental and Optometry (POD)



**Bedfordshire, Luton
and Milton Keynes**
Integrated Care Board

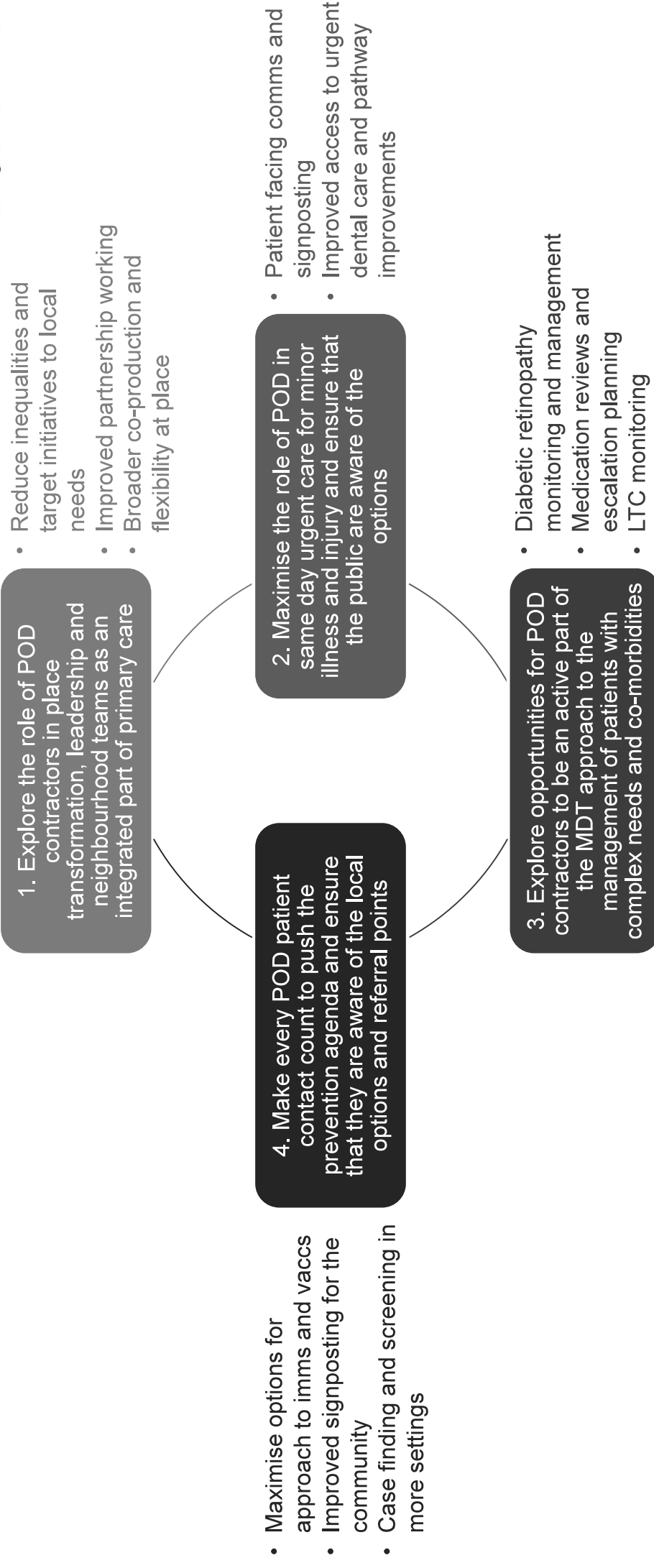

How we plan to maximise the opportunities of delegation



Bedfordshire, Luton
and Milton Keynes
Integrated Care Board

Improved engagement with providers

Relationship building across all of Primary Care

Co-design of local solutions

Getting the best from the contracts as they stand

Re-procurement of Specialist Community Dental Services in 2023 targeting inequalities

Understanding and responding to local needs - flexibility at place level

Standardise approaches across BLMK where it makes sense and creates efficiency

Known issues



**Bedfordshire, Luton
and Milton Keynes**
Integrated Care Board

The delegation readiness processes, and early engagement with contractors and their representatives has highlighted a number of issues that will need to be better understood and, where possible, addressed. These include:

Budgets	Contracts	Workforce	Access
<ul style="list-style-type: none">• The budget for POD contracting is ringfenced with no additional funds for transformation• The budget for Dentistry will be ringfenced separately within the ICBs budgets to ensure it is protected for dental services• We don't have additional monies to invest without taking these from somewhere else in the system	<ul style="list-style-type: none">• POD contracts are nationally negotiated, and have limited opportunity for flexibility or the development of locally specified services• The current NHS Optometry and Dental contracts are not attractive to providers. Many have already moved to private practice and there is a sense that more could do the same unless the terms are improved, but this is outside of the ICB's control• There is no requirement in the contracts for POD providers to play a part in service development unlike other providers	<ul style="list-style-type: none">• There are national recruitment issues within POD that mirrors many other health services including GP practices• This, coupled with the limitations of the national contracts, means that provision going forward is likely to be constrained• Limitations within the contracts have restricted opportunities for modernisation and MDT working which has meant the delivery models for NHS care are comparatively expensive (e.g. need to be performed by a Dentist rather than Dental Technician even though competencies are met)	<ul style="list-style-type: none">• A lack of access to NHS Dental and Optometry care most negatively affects the most disadvantaged populations who also have the most need• There is a high level of known unmet need, with more work to be done to understand the unknown need and the impact on broader health outcomes• There is a backlog of secondary dental care which needs to be addressed with local acute providers – through e.g. theatre capacity but also staff resources.• Backlog of need adds to the access and affordability challenges for the ICB

Opportunities to explore going forward

Existing contracts

- All contracts have an element of Public Health provision, and we think this is currently underutilised / not focussed on specific local need
- NHS Community Pharmacist Consultation Service (Minor Illness and Urgent Repeat Medicines Supply pathways) is currently underutilised and could have a bigger impact on Primary Care with more public awareness and more Pharmacies opting to provide it
- Existing additional services such as hypertension case finding could be better used / integrated
- Current pilot for read and write access to SystemOne within pharmacies could be expanded
- Opportunities to explore pharmacy-based prescribers to reduce load on primary care following national proof of concept

Transformation at place

- Embedding POD contractors as an important part of the place solution – enabling co-production at a local level to respond to specific needs
- Build on the success of the Covid-19 vaccination programme with all pharmacies supported by a new Community Pharmacy Transformation Lead
- Explore how we can maximise the opportunities in the current contracts around public health, prevention and early identification of health risks
- Improve public and system awareness of what POD provides and ensure that POD contractors are aware of the local pathways in place / in development

Case studies



**Bedfordshire, Luton
and Milton Keynes**
Integrated Care Board

Improving oral health in Care Homes

“My Mouth Matters”

- 10 dental providers are taking part in this across the region including BLMK
- Piloting the use of a new treatment for badly decaying teeth in residents in elderly care homes that often get overlooked
- Treatment stops further deterioration of the decay and reduces the risk of the patient needing to be admitted to hospital for general anaesthetic removal which can negatively affect general being and exacerbate confusion and worsen Alzheimer's

Looked after children

- Specialist community dental services (SCDS) provides dental care to people with special care needs and usually complex needs including children
- They deliver My Smile award and the Let's Brush programmes in our area
- Both programmes support targeted early years settings with daily supervised toothbrushing
- My Smile extends to ensure that the settings are tooth friendly in their everyday practice
- They do this by offering training to nurseries, schools a
- and health professionals working with looked after children whose oral health needs often get overlooked

Indicative priority timeline

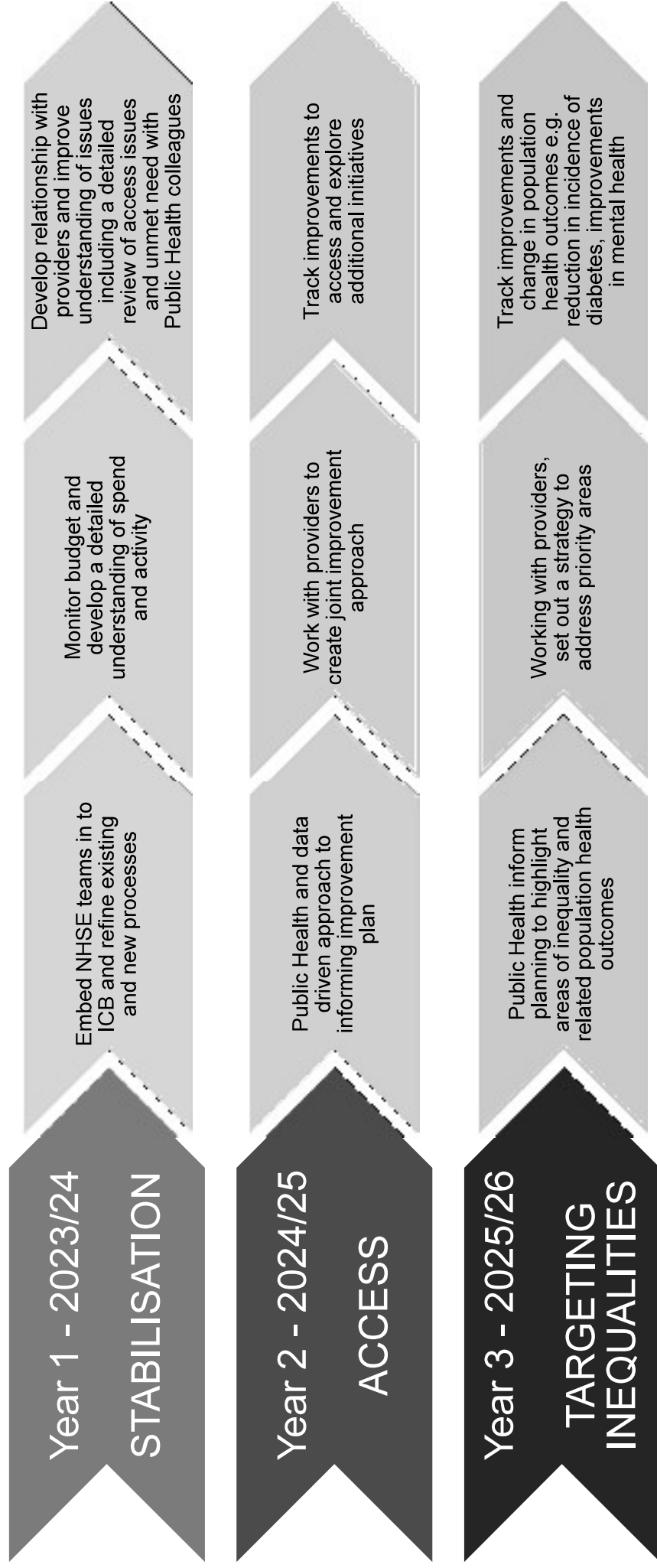

Key points



The delegation of these contracts gives all partners an opportunity to work differently to deliver, amongst other things, the BLMK Fuller Programme, improve prevention and reduce inequalities

The involvement of POD colleagues in co-production will bring a different element to the art of the possible

The contracts are not locally negotiated, so we do have some constraints, but that should not limit our ambition for inclusion

The ICB will continue to monitor the risks and implications of delegation as well as the opportunities to provide the assurance that is needed for a safe transition



Bedfordshire Luton & Milton Keynes Mental Health, Learning Disability & Autism: collaboration to improve outcomes

Item 9 Health and Care Partnership
7 March 2023

Richard Fradgley and Ross Graves



Introduction



The purpose of this document is to provide members of the Integrated Care Partnership with a high-level overview of:

- Progress made nationally in delivery of the NHS Long Term Plan for mental health
- Some of the progress made with improving mental health services in Bedfordshire, Luton & Milton Keynes over the past several years
- Some of the progress made with improving NHS commissioned services for people with learning disability & autism over the past several years
- Some of the context for the future
- An outline of the opportunity for deeper collaboration across partners and places to drive improved outcomes, quality, value and equity for the people that we serve who have, or are at risk of, mental health conditions and/or learning disability and autism.

The pack is not exhaustive and is not intended to be so – it is anticipated it will help to inform the discussion around opportunities, risks and next steps at the Integrated Care Partnership on 7th March 2023.



1. Progress in improving mental health services in England



National Audit Office (2023) – Mental health in England since 2017

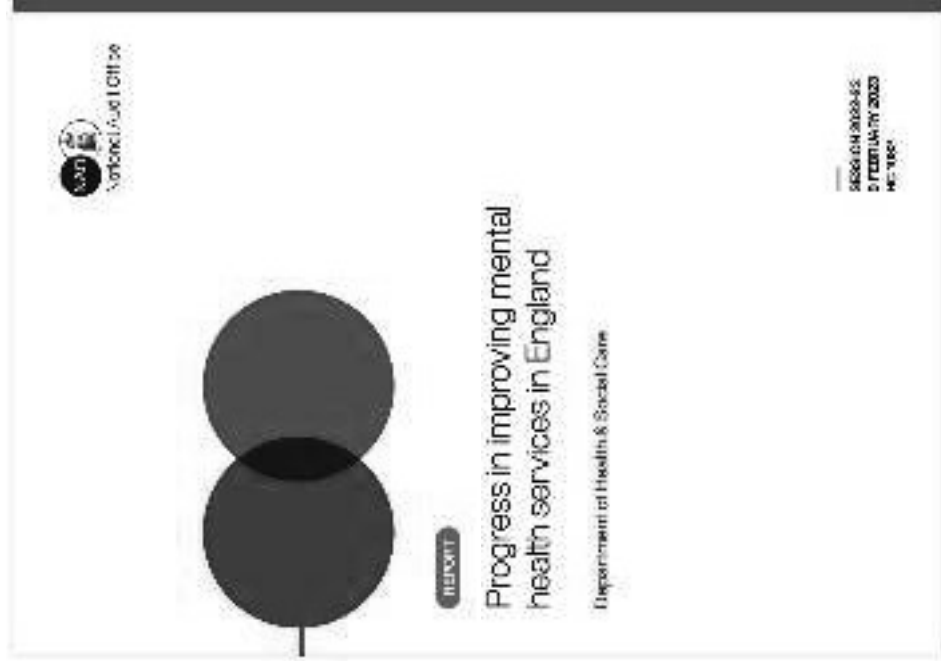

- **4.5m** - Number of people in contact with NHS-funded mental health services during 2021-22
- **£12.0b** NHS spend on mental health services in 2021-22, equivalent to around 9% of the NHS budget
- **4.9 times** people with severe mental illness more likely to die prematurely than the general population during 2018–20
- **22%** (24,000) increase in NHS mental health workforce between 2016-17 and 2021-22
- **44%** increase in referrals to NHS mental health services between 2016–17 and 2021-22, from 4.4 million in 2016-17 to 6.4 million in 2021-22
- **8 million** - NHS England estimate of the number of people with mental health needs not in contact with NHS mental health services, as of 2021
- **1.2 million** estimated number of people on the waiting list for community-based NHS mental health services at the end of June 2022
- **26%** estimated proportion of 17- to 19-year-olds with a probable mental disorder in 2022, increasing from 10% in 2017
- **17%** proportion of NHS mental health funding spent on non-NHS providers, including independent and voluntary sector providers, in 2021-22
- **61%** for July to September 2022, proportion of referrals to talking therapy services excluded from calculation of waiting time standards





“Improving NHS mental health services is an important component of the government’s ambitions to achieve broader parity of esteem for mental health and wellbeing. We make the following recommendations to ensure further progress towards this. DHSC and NHSE should publish a detailed statement of what achieving full ‘parity of esteem’ between mental and physical health services encompasses, in terms of access and service standards, staffing model and funding allocations, and the road map for national bodies, ICBs and local providers to achieve it.”

RECOMMENDATIONS

1. DHSC and NHSE should publish a detailed statement of what achieving full ‘parity of esteem’ between mental and physical health services encompasses, in terms of access and service standards, staffing model and funding allocations, and the road map for national bodies, ICBs and local providers to achieve it.
2. Either separately or as a distinct part of the overall NHS workforce plan due in 2023, DHSC and NHSE should publish a longer-term mental health workforce recruitment and retention strategy and a costed plan, that reflects the volume and skills required to meet future service ambitions. They will need to engage closely with HM Treasury in this process. The strategy should include how they will work with ICBs on local workforce development, recruitment and retention.
3. NHSE, working with local ICBs and providers, should improve its data and analysis to better understand the relative cost and cost-effectiveness of different services, and provide a more robust basis to decide future priorities.
4. NHSE, working with ICBs, should develop and issue guidance in 2023 on how the system will gain more transparency over capacity, activity, performance and outcomes in community mental health services, including improvements required to implement the proposed new clinical standards, as well as mental-health- related capacity and activity in primary care.
5. As mental health services will need to remain the focus of sustained improvement and in the light of the national and local reorganisation of health bodies, DHSC and NHSE should set out the future approach to leading, monitoring and assuring oversight of mental health service expansion and improvement. This should include how they ensure that ICBs and NHS providers have sustainable plans for workforce and service models in the short to medium term.



2. Progress in improving mental health services in Bedfordshire, Luton & Milton Keynes



Our Journey – What the MH Programme has achieved since 2018/19



Perinatal

More pregnant women and new mothers receiving perinatal mental health care than ever before and new maternal mental health services to support people who have sadly lost their baby or had a miscarriage

Expanded perinatal service offer to increase access to psychological therapies
Service includes offer for partners
Also available for patients up to 24 months post partum

CAMHS

New community crisis teams, crisis sanctuaries for children and young people, and much greater capacity in our CAMHS services to support children, young people and their families

Increasing access for CYP
New mental health in schools teams, supporting hundreds of pupils and teachers

BLMK CAMHS Tier 4 inpatient unit due to open imminently - Evergreen

NHS Talking Therapies

Treating more adults with anxiety and depression in primary care talking therapies than ever before

Long Term Condition services in place, including post Covid syndrome
Continue to meet 50% recovery rate, 75% accessing within 6 weeks and 95% within 18 weeks

Early Intervention

Early intervention services that are the best quality in the whole of the east of England (as per national 2022/23 EIS audit)

Overachieve vs 60% target of patients requiring Early Intervention for Psychosis (EIP) receiving NICE concordant care within two weeks

Community Mental Health Team

Embarked on the most ambitious programme of transformation of community mental health services in 20 years, building new community teams around neighbourhoods, working in a much more integrated way, with a real focus on broader psychosocial support, addressing inequalities, connecting people to communities, supporting more people into work and offering more physical health checks than ever before

A range of new roles in place including peer support, drug and alcohol, primary care ARRS roles
Recovery college open in MK

Our Journey – What the MH Programme has achieved since 2018/19



Crisis

New crisis pathways, with access to crisis support via 111, crisis teams that can visit people in their own homes as an alternative to hospital (24/)

Alternative crisis offer via new crisis cafes across BLMK delivered in partnership with VCSE

Mental health teams in our acute hospitals meeting national guidance and “core 24” standard

Dementia

Memory assessment services expanded

Above East of England and England average for Dementia diagnosis and just below national target (63.9% vs 66.7% target)

Inpatient

UEC capital funds – for MK developing HBPos this year. Next year developing Crisis Lounges

Sensory – investment in to Campbell Centre to enhance therapeutic environmental internally and in the garden. Includes training for staff and new sensory equipment

Developed case for change for Bedford Health Village and Stage 1 designs in development

Demand remains a challenge but despite this 72 follow up and length of stay remains positive

Suicide Prevention

Work to develop prevention initiatives well underway through the prevention concordat with local authorities, and a well-developed suicide reduction partnership and plan

Other

Rough sleeping services in place – MK and Luton

Establishing Gambling Service for the whole EoE region

Established Keeping Well Service – Staff Support Hubs

Our Context – Demand for Services – CAMHS



Points to Note:

- Significant demand and acuity increase in CAMHS exacerbated by the pandemic
- Waiting times for community eating disorder remain challenging and are below the national target
- Significant investment has supported expansion of core CAMHS services and eating disorder services as well as establishment of CAMHS crisis services, crisis café and day care
- In addition the first BLMK CAMHS Tier 4 ward is due to open in early 2023 (8 x General Adolescent Unit Beds - GAU)
- Roll out of mental health schools teams with more planned in 23/24
- Capacity issues remain a challenge despite investment

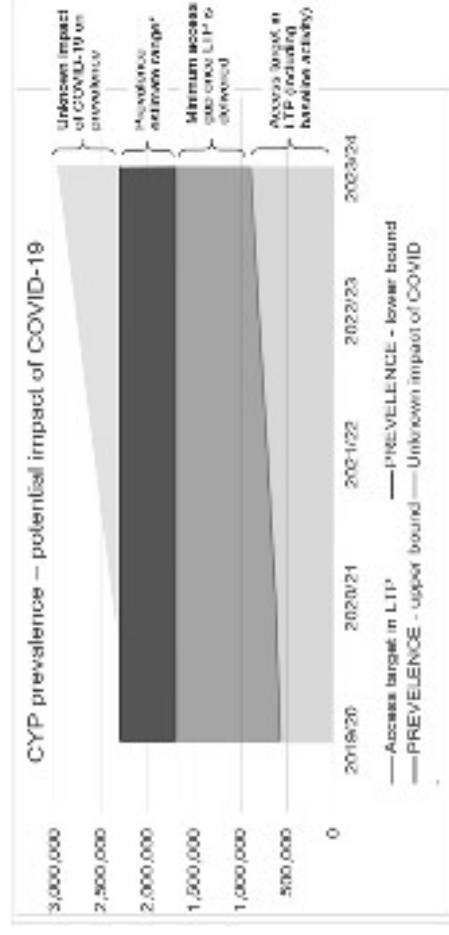
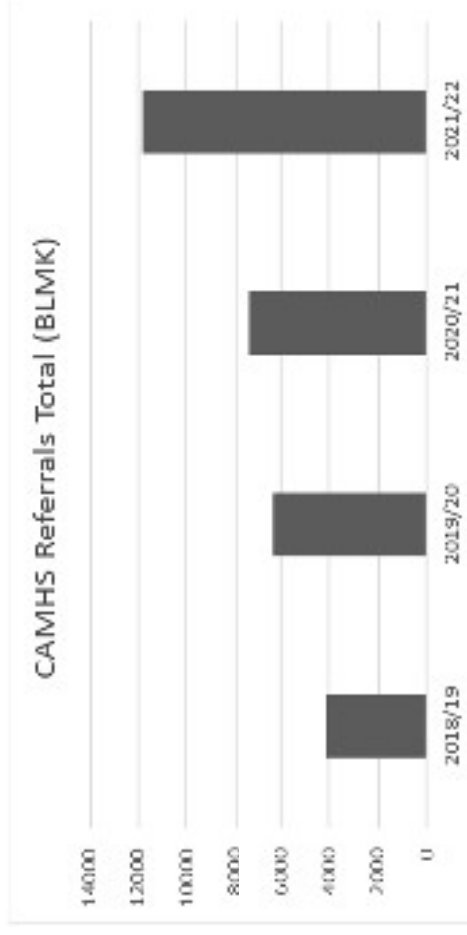

Our Context – Demand for Services – Primary Care Talking Therapies



Points to Note:

- Access rate has continued to increase in line with NHS Long Term Plan
- Recovery rates broadly above 50% access target in last 3 years
- BLMK primary care talking therapies (IAPT) collaborative group meets regularly for clinical and operational leads to problem solve
- Vacancies remain a challenge and a recruitment programme of work underway with East of England support
- While record numbers of people are now accessing IAPT services, the Long Term Plan only partly addresses the long-standing treatment gap for people with mental health problems. This has been further exacerbated by COVID and it's social and economic legacy and will only be heightened by the prevailing economic conditions
- This may be demonstrated locally by the rising primary care register for depression

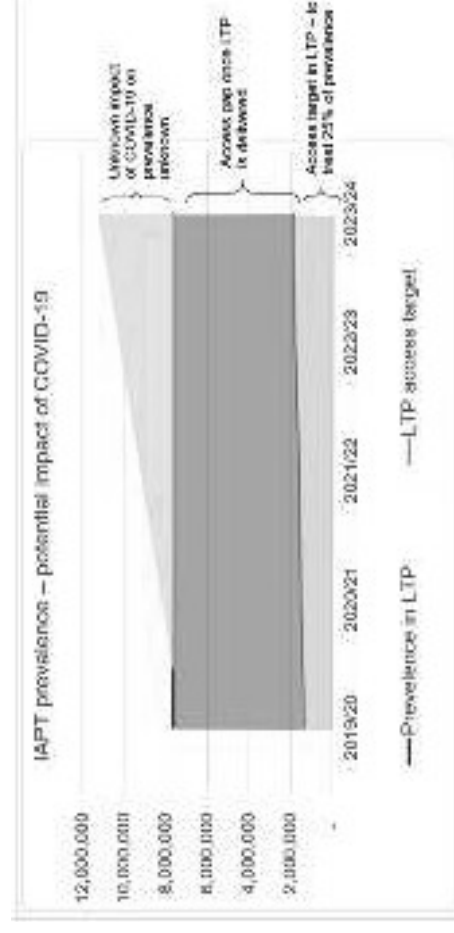
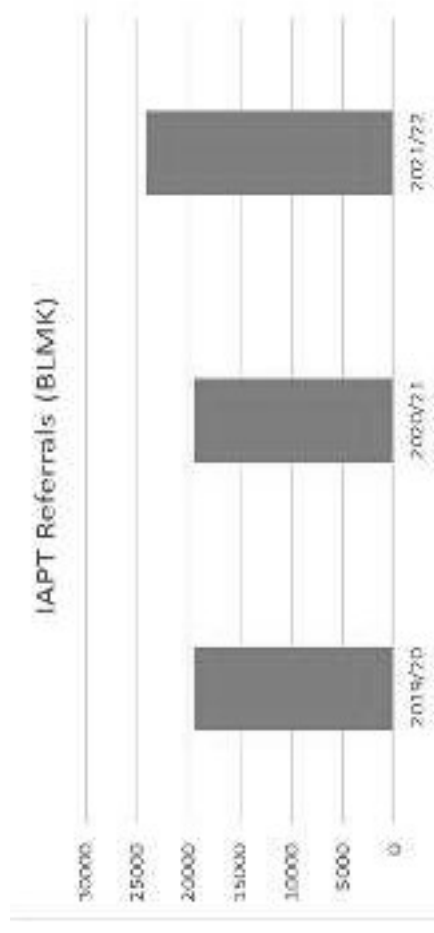

Our Context – Demand for Services – CMHT



Points to Note:

- Demand has increased by 44% since 2018/19
- Building new community teams around neighbourhoods
- Expansion of roles - community connector, substance misuse workers, carer link workers, embedded mental health roles in primary care
- Expansion of Adult Eating Disorder capacity towards national staffing model to enable access to earlier treatment and intervention
- Community rehabilitation – transforming the rehabilitation pathway including development of a community rehab team (B&L) and system wide programme to improve commissioning, quality and value of placements
- Complex needs associated with a diagnosis of 'personality disorder' - development of new models of care with a focus on improved access and experience for people with complex needs, their family and carers.
- Trauma-informed training has been delivered to embed trauma-informed care across our systems alongside an expansion and evidenced based therapy training (HEE funded) of a dedicated workforce
- Individual Placement Support (IPS) – embedded within community teams and currently meeting access

Number of CMHT Referrals (BLMK)

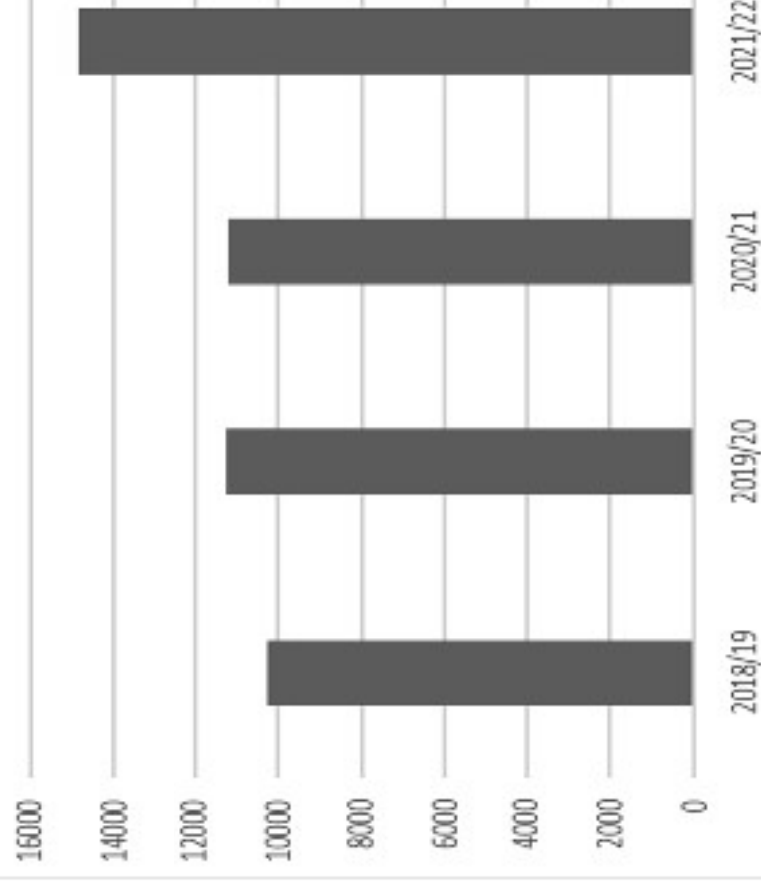

Our Context – Demand for Services – Crisis Teams



Points to Note:

- Referrals to crisis teams increased in 2020/21 but dropped in 2021/22 which may be due to the expansion of alternatives on offer
- Expanded crisis teams are in place and can visit people in their own homes as an alternative to hospital 24/7
- New crisis cafes in place across BLMK
- Crisis support available via 111 (ELFT only)
- Expansion of psychiatric liaison capacity in A&E to meet national guidance (CORE24)

- Note: data taken from Crisis / Home Treatment Team

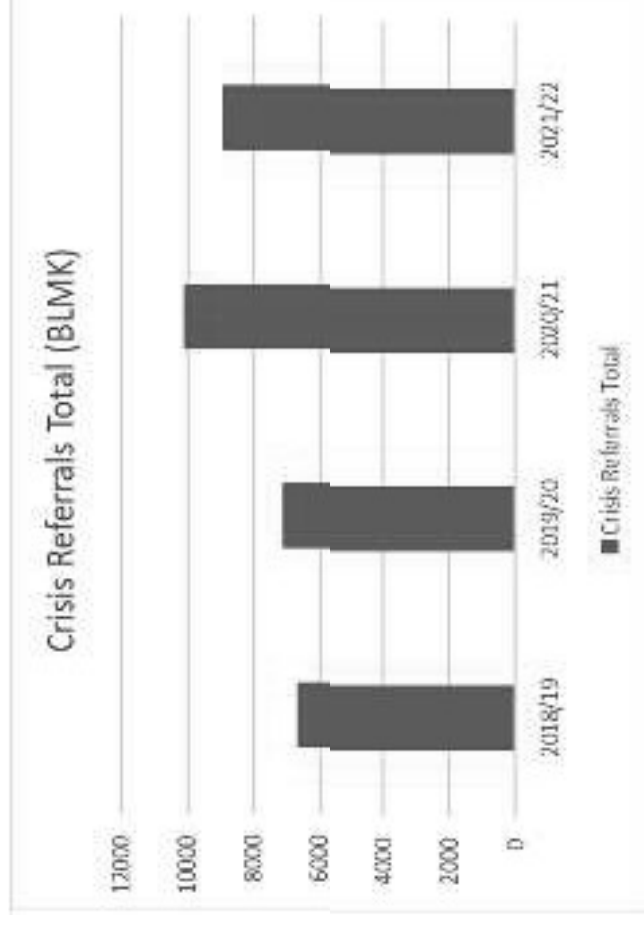

Our Journey – Investment in staffing since 2018/19



Spend on MHLDA across BLMK has increased from £165m in 2018/19 to an estimated £224m in 23/24. This represents a 41% increase during this period.



Meanwhile total budgeted staff has increased from 1593 in 2018 to 2189 in 2022.

Vacancy rates have fallen slightly during this time from 19% in 2018 to 17% in 2022 though total number of vacancies has grown from 318 to 409 with the largest number of vacancies in nursing but pressures also seen in medical staffing.

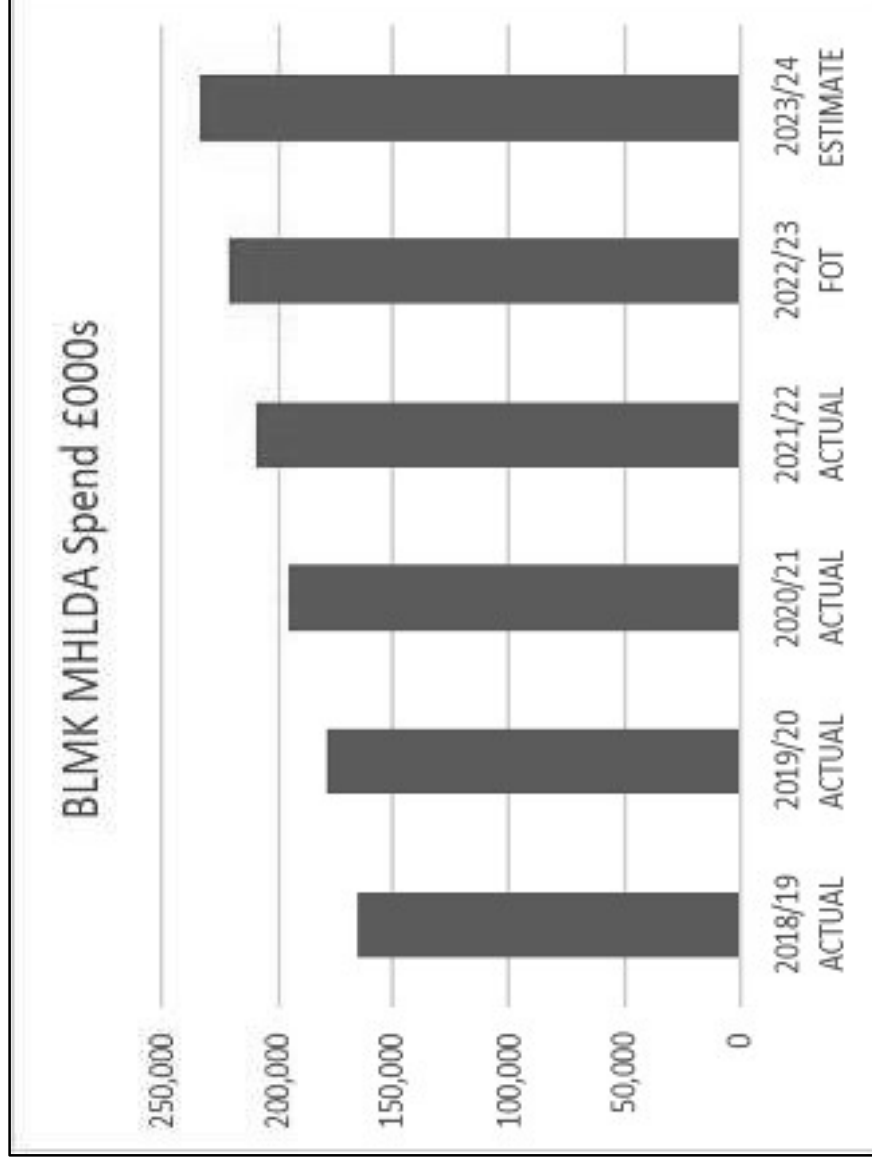

Our Context – Outcomes and Quality

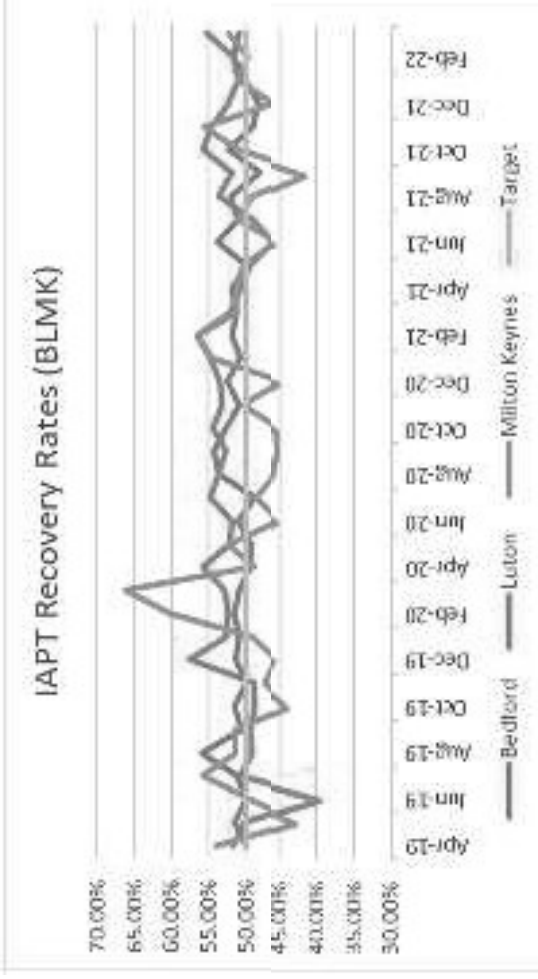

Adult Mental Health Outcome Measures

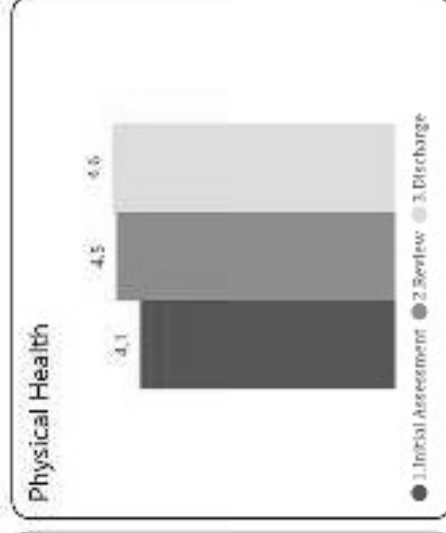
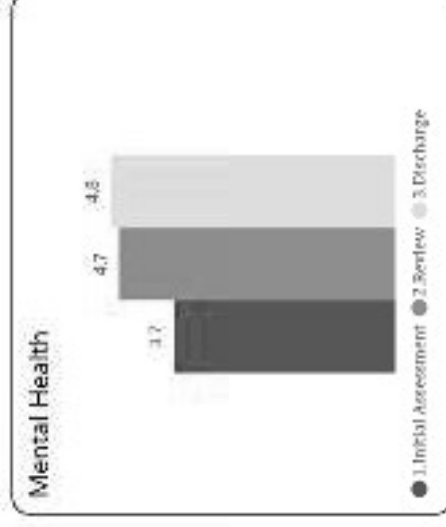

- Recovery rates are routinely collected for IAPT (now known as NHS Talking Therapies for Anxiety and Depression)
- Recovery rates have been broadly above 50% across BLMK

- Across BLMK routine outcomes measures for secondary care mental health are now being routinely collected as part of community mental health transformation
- DIALOG PLUS captures the service user health and wellbeing across 8 domains: mental health, physical health, job situation, accommodation, leisure, friendships, relationships and personal safety



3. Progress in improving NHS commissioned learning disability & autism



Learning Disabilities and Autism (Transforming Care Programme)



National NHS policy to date has had a significant emphasis on supporting people with a learning disability outside of hospital and ensuring people with a learning disability have physical health checks annually undertaken by their GP.

Transforming Care Programme Adults and CYP Inpatients – Learning Disability and/or Autism as at end of December 2022

Inpatients beds for Adults - Total	End of December 2022		End of Nov		End of Oct		Narrative (since last reporting period)
	Performance	Trajectory	Perf	Traje	Perf	Traje	
BLMK Inpatient beds Adults Total	23	26	23	26	22	26	Overall, there continues to be 3 patients below trajectory target.
Inpatients beds for Children & Young People Total	6	3	5	3	8	3	Overall for Children & Young People patients continue to be over trajectory. This is by 3 patients, following an admission since the last reporting period. There is a CYP Plan in place for CYP experiencing delayed discharge. Safe and wellbeing reviews have been completed for 2 long stay patients.

Points to Note:

- The national Transforming Care programme aims to improve the lives of children, young people and adults with a learning disability and/or autism who display behaviours that challenge, including those with a mental health condition, in particular through enhancing community capacity, thereby reducing inappropriate hospital admissions and length of stay
- Bedfordshire Luton & Milton Keynes Transforming Care programme board has led multi-agency work to deliver the national programme, and has made good progress in providing support for adults with a learning disability outside of hospital, and focussed work underway with regards to children and young people
- There is much innovation underway, including Care (Education) & Treatment reviews being undertaken by ELFT on behalf of the Integrated Care Board in Bedfordshire and additional personal health budget funding has been secured to support young people with learning disabilities/autism who are most at risk of admission and includes those awaiting an assessment.



Learning Disabilities and Autism (Health Checks)



Points to Note:

- People with learning disability die much younger than the population more generally. Physical health checks undertaken in primary care are an important part of ensuring that physical health problems are detected and treated early
- Bedfordshire Luton and Milton Keynes currently perform about average for the region, with opportunities for further improvement
- Health checks tend to be undertaken across the year but in particular in the last quarter of the year (and are then reset at the beginning of the next year)
- As of January 2023, 93.12% of BLMK patients receiving a healthcheck also received a Health Action plan, compared with 85.43% in the previous financial year.

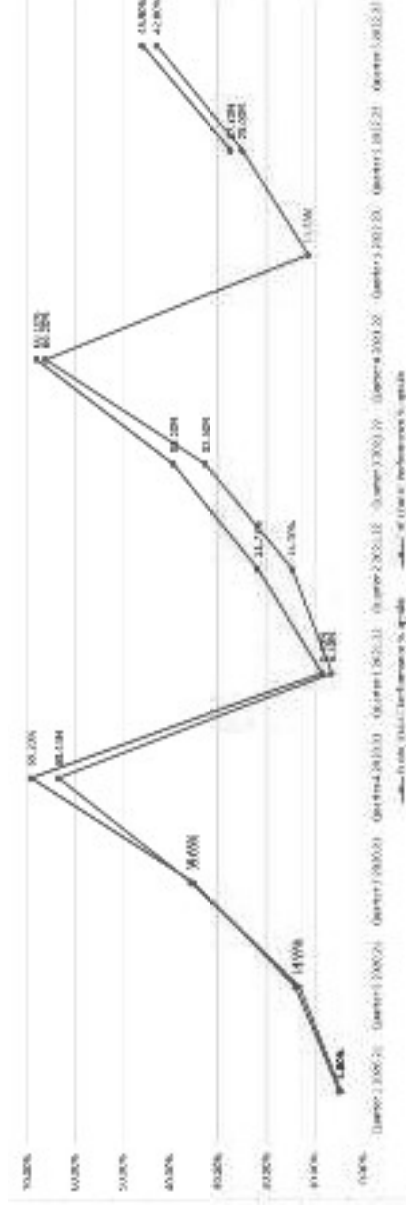

Learning Disabilities and Autism (Autism Diagnosis)



Points to Note:

Referrals for autism assessment are rising, with lengthy waiting times. We are currently undertaking the following to help meet this need:

- A BLMK Autism Review has been commissioned and recommendations are being developed
- Pre-diagnostic support has been commissioned across BLMK for people on the waiting list that enables people to access support while they wait to be assessed
- Additional funding to support backlog of assessment for autism for children and improve waiting times, activity has been agreed and additional assessments will be completed by March 23
- Development of a BLMK Neuro Developmental Disorders (NDD) pathway across health, education and social care, is underway

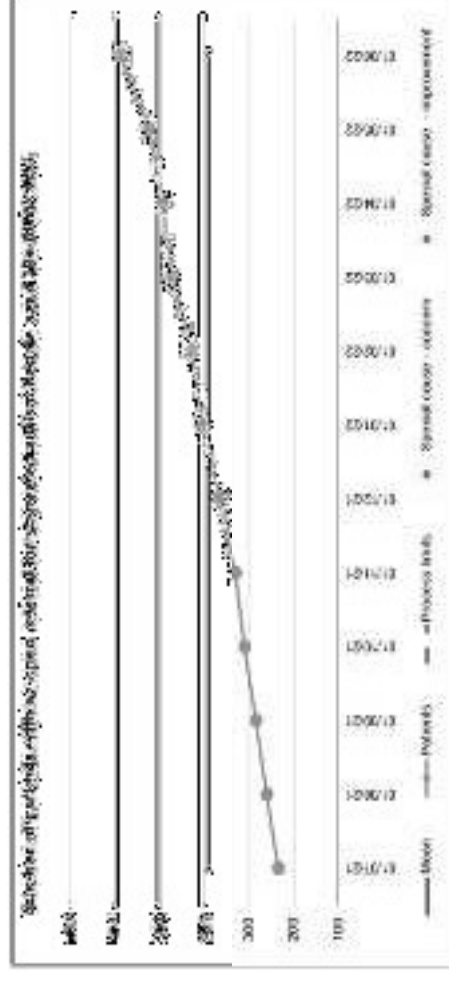
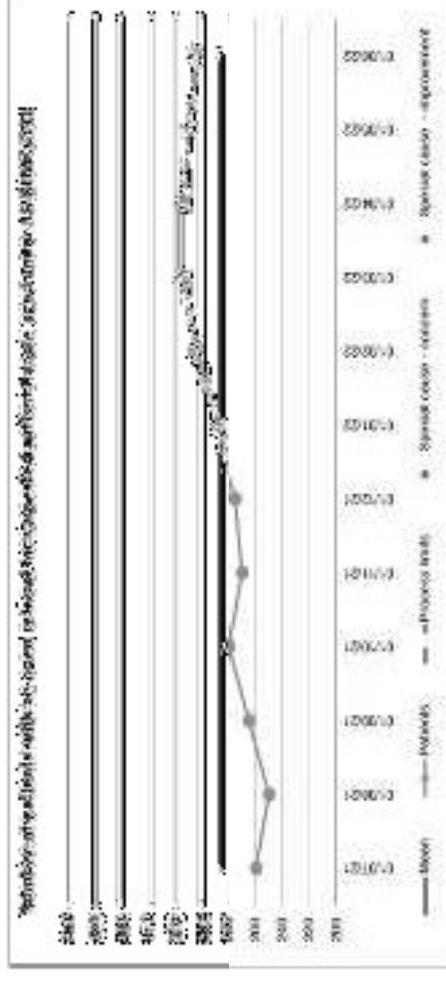

4. Context for the future



Our Context – Population Projections by Place



- Population is set to grow significantly in the over 65 age group with the highest growth in MK at 63% meaning capacity for OPMH services will need to be addressed
- Working age adults and Under 20 are set to fall in Luton and Milton Keynes but grow in Bedford and Central Bedfordshire. However these projections are based on average migration (principal ONS) and when viewing high migration projections or more recent 2021 census data these figures are likely to be higher
- E.g. in Luton original 2018 projections were for a fall of 0.8% in Luton between 2018 and 2021 however the latest census (2021) shows a growth of 5%

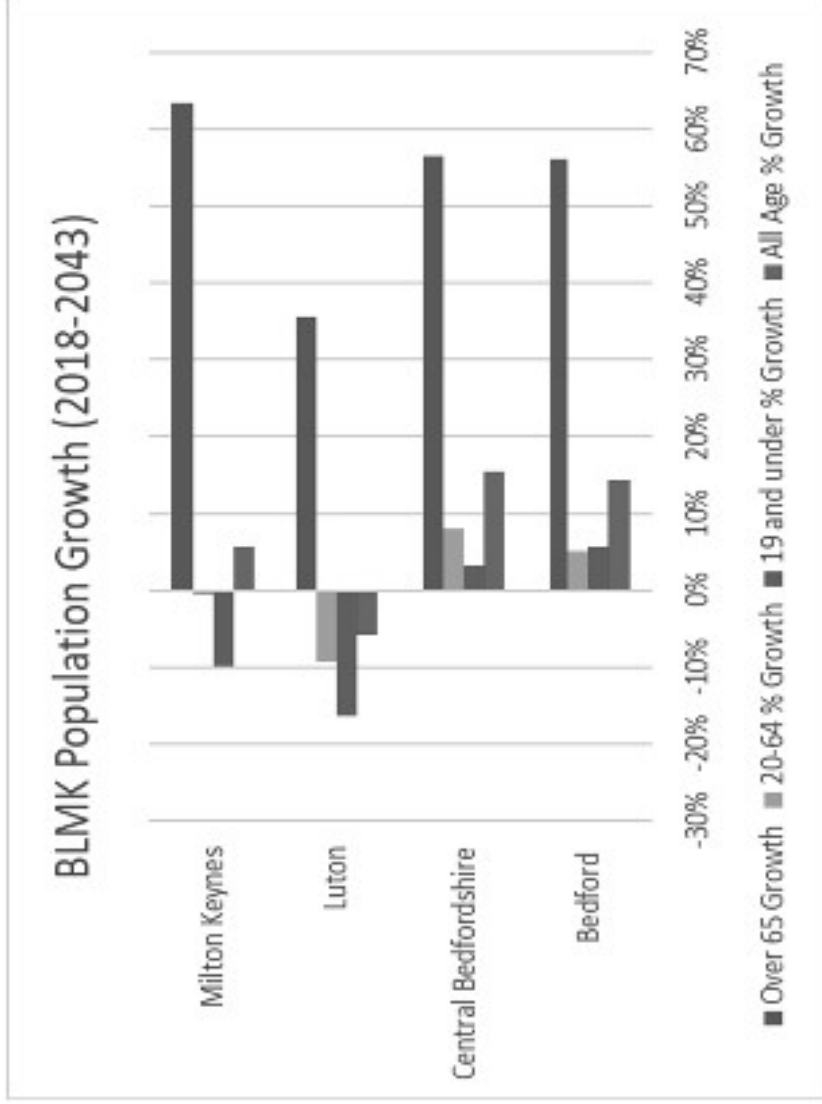

Source: 2018 ONS Sub National Principal Projection



Our Context – Primary care register changes since 2018/19

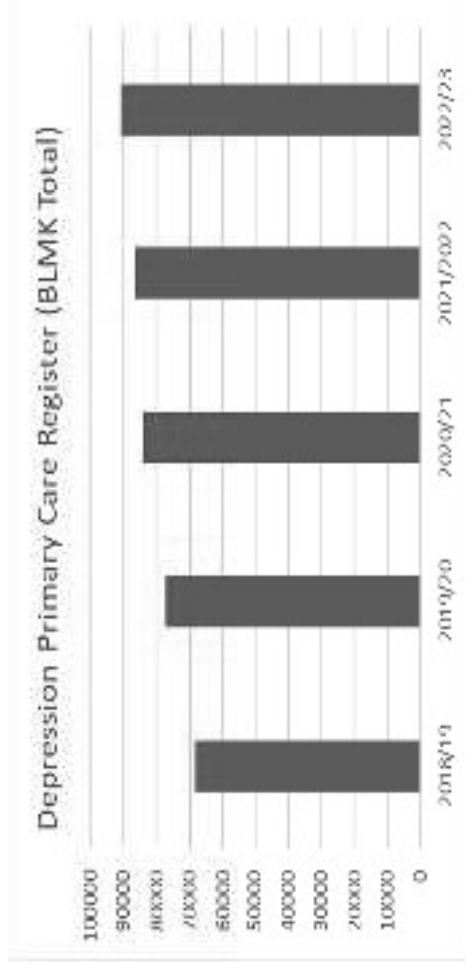

- Primary care registers for depression have increased year on year with a 33% increase between 2018/19 and 2022/23
- The largest increase recorded in Bedfordshire (BBC and CBC) at 34% with Luton and Milton Keynes at 30%

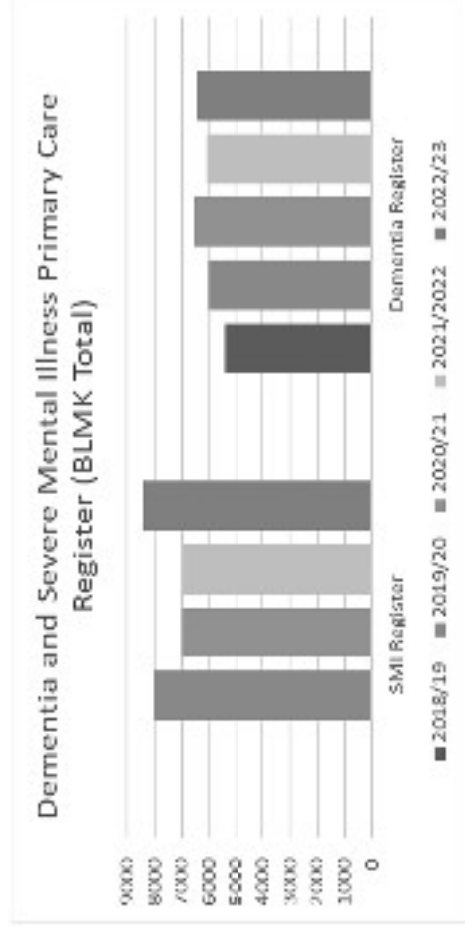

- Primary care registers for severe mental illness (SMI) have grown by 5% between 2019/20 and 2022/23 (note 2018/19 is excluded due to register not being complete)
- Primary care registers for dementia have grown by 19% between 2018/19 and 2022/23



Our Context – Mental Health, learning disability and autism need



25% of patients in BLMK with a long-term condition also experience mental health needs and people with a **severe mental illness** have much **lower life expectancy** than that of the general population, largely due to a higher prevalence of physical conditions.

- In BLMK there are currently just under 8,000 patients on the severe mental illness (SMI) register and, of these, **57% have a recorded annual health check**. The target is 60%.
- The need for mental health support is growing more and more every year. **The number of referrals to mental health providers increased by 20%** in BLMK from 2020/21 to 2021/22, with the largest increase (26%) among working age adults.
- **25% of BLMK patients who have a long-term condition also have a recorded mental health need**. Patients with cancer (35%) and frailty (43%) are more likely to have this.
- Although we are close to the national Dementia diagnosis target there remains unmet need and BLMK has 3,500 fewer patients with a diagnosis of dementia than expected. The current prevalence is 3.8% of patients aged 65 and over.
- Compared with the general population, **adults with SMI die 15-20 years earlier** from a range of conditions, including cancer, cardiovascular, respiratory and liver disease.
- People with a **learning disability or autism** are less likely to attend screening, face long waiting times, and die on average 14 years before the rest of the population
- Interventions to address the building blocks of health (e.g. employment and housing), address risk behaviours, improve access to care, and support self-management of conditions will help address health inequality experienced by people with SMI.

Adults with severe mental illness (SMI) are more likely to have physical health conditions

When compared to the general population of the same age group, people with severe mental illness (SMI)* aged 15-74 are more likely to have:

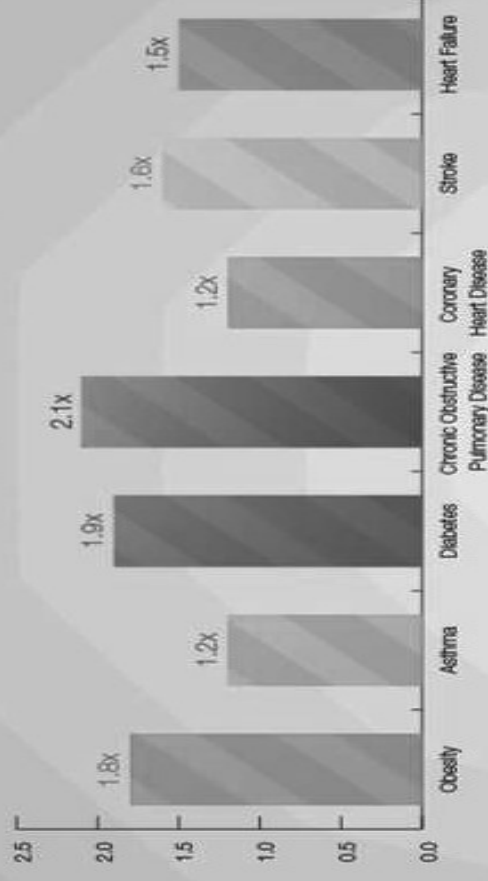

*Sample of people with SMI registered with a general practice

Our Context – Place based priorities

Each of our Places have highlighted significant priorities within their plans, to improve outcomes for children and adults experiencing mental illness



Bedford

'People of all ages and backgrounds have a right to good health and wellbeing. We will take a whole life course approach, with equal emphasis on improving physical and mental health, and a focus on reducing health inequalities.'

Priorities include:

- Undertake an all ages mental health needs assessment .
- Ensuring the new perinatal MH service is effective and embedded within the pathway
- Developing the offer to support emotional health and wellbeing.
- Address the rise in referrals to the Eating Disorders service.
- Continue to embed the KOOTH and promote via schools and other frontline professionals
- Expand services and provide faster access to community and crisis mental health services for CYP Support the delivery of SEND Joint Action Plan, including support within ND diagnostic pathways
- Implement the Community Mental Health Framework, including:
- Accelerate the roll out of Personal Health Budgets to give people greater choice
- Progress plans for mental health inpatient provision for adolescents closer to home
- Develop system-wide resilient provision across primary care, integrated urgent care, community, mental health services as well as hospitals

Central Bedfordshire:

'Everyone should have the right and opportunity to live their best life, with the required support and infrastructure to make healthy choices and maximise wellbeing.'

Priorities include:

- Focus on **improving mental health and wellbeing**, including:
- Developing integrated community mental health services
- Using a Population Health Management approach to implement and evaluate interventions to improve mental health and wellbeing in 16 – 25 year olds
- Improving uptake of physical health checks for people with SMI
- Ensure good knowledge of and access to activities to tackle social isolation and loneliness, including those which also improve healthy lifestyles such as increased use of the natural environment e.g. green social prescribing
- Improve **access to intermediate care services** and explore options to **integrate health and wellbeing** services, moving away from separate service responses
- Implementing actions at place level in line with our **suicide prevention** plan, building services in line with our zero suicide ambitions



Our Context – Place based priorities

Each of our Places have highlighted significant priorities within their plans, to improve outcomes for children and adults experiencing mental illness



Luton

‘Luton is a community where I feel listened to, believed, understood and supported to be come the person I want to be.’

Prevention

- People supported to maintain and improve their wellbeing when required
- Reduced crisis/demand management
- Promotion of self help to build personal resilience
- Reduced stigma around mental health; enabling people to seek support when they need it
- Intervene earlier in young people services as a method of prevention
- Greater community resilience – “Community manages itself”
- Prevention approaches built in to all services

Priority 2: Access

- No wrong door
- Access and options are increased through improved knowledge, integration and connection between services People accessing services when they need to
- Directory of voluntary sector providers
- People understanding where to get the help they need
- Access equitable for BAME and other high priority groups
- Support for families and carers
- Mental health support in place for staff

Milton Keynes

‘Staying well- A strong focus on prevention, Closing the Gap- reducing health inequalities & One MK- an integrated, innovative approach to health and wellbeing.’

Starting well: Help children and young people to better mental health. Improve the life chances of CYP special educational needs and disabilities. Support the wellbeing of all pregnant women

Living well: Improve the lives of everyone living with mental illness through raised awareness and more effective support services. Ensure people with autism receive earlier diagnosis, access to high quality information and more employment opportunities

Aging well: Promote positive MH and reduce social isolation

MK Deal priorities include

- Children & Young People’s Mental Health
 1. Closer working between system partners
 2. Getting advice and getting help
 3. Joining up training on Neurodevelopmental Pathways
 4. A smoother crisis offer
- **Complex Care:** Complex Care is focused on the improving the planning, assessment, commissioning, and case management for people who have the most complex need



Our Context – the journey to date



- The BLMK mental health programme has grown and matured since its inception in 2015. We have a “one team” approach across commissioners and providers and are currently working with an unprecedented level of **collaboration**, with **much more transparency, trust**, and with people working across our organisations in the interests of the population we serve
- As a consequence, we are delivering on **improved outcomes, quality and value** for residents of BLMK in a number of areas that have previously been “stuck”
- We are **working collaboratively to tackle knotty local issues** (e.g. Section 117 Aftercare), and to improve outcomes for people using pathways that typically span multiple health and care providers and involve a multiplicity of stakeholders (e.g. dementia)



Our Context – co-producing our plans for Evergreen



In Feb/Mar 2023, BLMK will open a new inpatient ward for children and young people at the Luton Centre for Mental Health – for the first time children, young people and their families will not have to travel far out of BLMK to be admitted.
 'Evergreen' was possible because of real collaboration and co-production across our system.



Nov 2021
 Codesign sessions with Architects.
 Focus on safe spaces; sensory needs and appropriate outdoor space

Jul 21-Jan 22
 Initial Scoping workshops and ongoing updates

- Monthly workshops hosted by BMLK Professionals for Young People & Parents/Carers
- Diverse representation from across BLMK



Dec 2021: Young People chose 'Evergreen' as the name of the unit



Oct 2022 Design chosen by YP



July 21
 Coproduction of the case for change

Jun 21 Initial workshop with YP to establish need



May 22: Building works begin

Sep –Oct 22: Joint development of Op guidelines

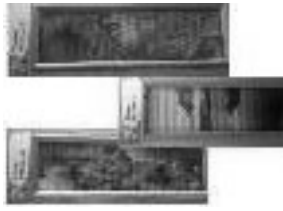

Our Context – what is important to service users and carers?

As part of the national 'Call for Evidence' Bedfordshire, Luton and Milton Keynes provided a collective response, with contributions from over 300 (all age) people and organisations.



01 Promotion

How will we promote positive mental health and wellbeing?

- By: education, training, self-care, social media, campaigns & inequalities and wider determinants

•E.g. **Self care-**

Feedback: Promoting self-care from an early age: Good sleep, healthy diet, exercise, being outdoors.

Outcomes: a Everyone will understand how they can improve/ support their own mental health and wellbeing. b. Everyone will know about the assets in their communities and what is available to support/encourage self-care.



02 Prevention

How will we prevent the onset of mental health conditions?

- By: communities, language & provision

•E.g. **Provision-**

Feedback: a. Service user led programmes b. Programmes which are culturally sensitive and appropriate. c. Mental health on the agenda at all health contacts.

Outcomes: All services will be coproduced and person centred.



03 Early Intervention

How will we intervene earlier when people need support with their mental health?

- By: early intervention, parents and carers & values

•E.g **Parents and Carers-**

Feedback: Better education for parents to recognise signs of poor mental health and wellbeing: In themselves, their partner, and their children. Training during antenatal health.

Outcomes: Parents/Carers are equipped with the information to recognise, understand and know how to access services.



04 Quality

How will we improve the quality and effectiveness of treatment for mental health?

- By: integration, communities, safe spaces, co-production, reducing barriers & easy access.

•E.g. **Integration-**

Feedback: Better integration of services and pathways i.e. drug and alcohol and mental health services.

Outcomes: a. The system will work in partnership to deliver joined up care and treatment. b. Children and young people will have a safe and positive experience of transition to adult services.



05 Support

How will we support people with a mental health condition to live well?

- By: resources, interventions, staff support, reduce waiting times, access to information, learning, partnership working, safety and quality, research & learning disabilities and autism.

•E.g. **Learning- Feedback:**

Learning from other services/area's to improve the quality of services.

Outcomes: We will provide high quality, evidence based services in all ages.



06 Crisis

How will we improve support for people in a crisis?

- By: training and awareness & beyond A&E.

•E.g. **Beyond A&E:**

Feedback: a. Increasing crisis alternatives including for young people. b. Developing a trauma informed approach. c. Increased support for carers and families. d. Improved crisis plans which includes an understanding of triggers for those around the individual.

Outcomes: Everybody will be able to access support in a crisis, in any setting.



5. Developing a deeper collaboration



Our Proposals – greater collaboration to accelerate improvement



- Over the past months preliminary discussions have been held with ICS partners about how we can collaborate more deeply to improve the mental health of residents of BLMK
- Formalising our way of working and extending our collaboration more deeply across the ICS, alliances, and places will allow us to make progress more quickly, and develop an integrated approach to whole population planning
- Our initial vision, which we will develop with input from service users, carers and system partners, will put service user voice and a focus on place at its heart, refocusing our efforts on addressing inequalities and unwarranted variation, and working at scale where it makes sense to do so
- A proposal to commence detailed design and planning for the collaborative with a view, to move into a shadow running period was endorsed by the ICB in November 2022
- Over the next several months we propose to develop a full proposal with service users and system partners which creates an operating and planning environment that integrates expertise across the BLMK system and that delivers the best possible outcomes for our residents
- As part of the design process, we need to understand and develop thinking on the role of the collaboration in planning services to meet the needs of those with learning disabilities and autism across BLMK: our Collaborative planning and design work around LD&A is less advanced than around mental health and we will engage with the key stakeholders from ICB and Places over Q4 and early Q1 to further scope this. We know that some of the considerations include:
 - The relationship between the proposed collaboration and existing Transforming Care Partnership
 - In MK LD&A services are mainly delivered by Milton Keynes City Council whereas in the rest of BLMK both ELFT and local authorities deliver LDA services. The context of these arrangements will need to be considered as part of the collaborative development.



Our Proposals – how the collaborative could make a difference



We will aim to:

- Refresh how we plan, deliver and hold ourselves accountable for outcomes, quality, value and equity through our placed based partnerships and alliances ensuring we co-produce with our service user, carers and communities
- Ensure that our work to plan and improve outcomes is done with the best expertise and evidence and in full collaboration between service users and carers, communities, expert clinicians, care professionals, voluntary sector
- Focus on collaboration and partnerships, reimagining the commissioning of the future with integrated whole population planning – with commissioning functions at scale and place
- Reach collective decisions about how to best use our resources to deliver outcomes at scale and at place. We will focus on reducing duplication, improving efficiency, and looking outward to those we serve
- Continue to test working in a more integrated way, with a clear focus on clinical and professional leadership, people participation and quality improvement
- Support collaborative responsibilities for commissioning at system/place, harnessing the skills and expertise of the BLMK workforce putting clinical, professional and service user leadership at the centre of decision making supported by integrated planning support.



Our Proposals – initial design thoughts

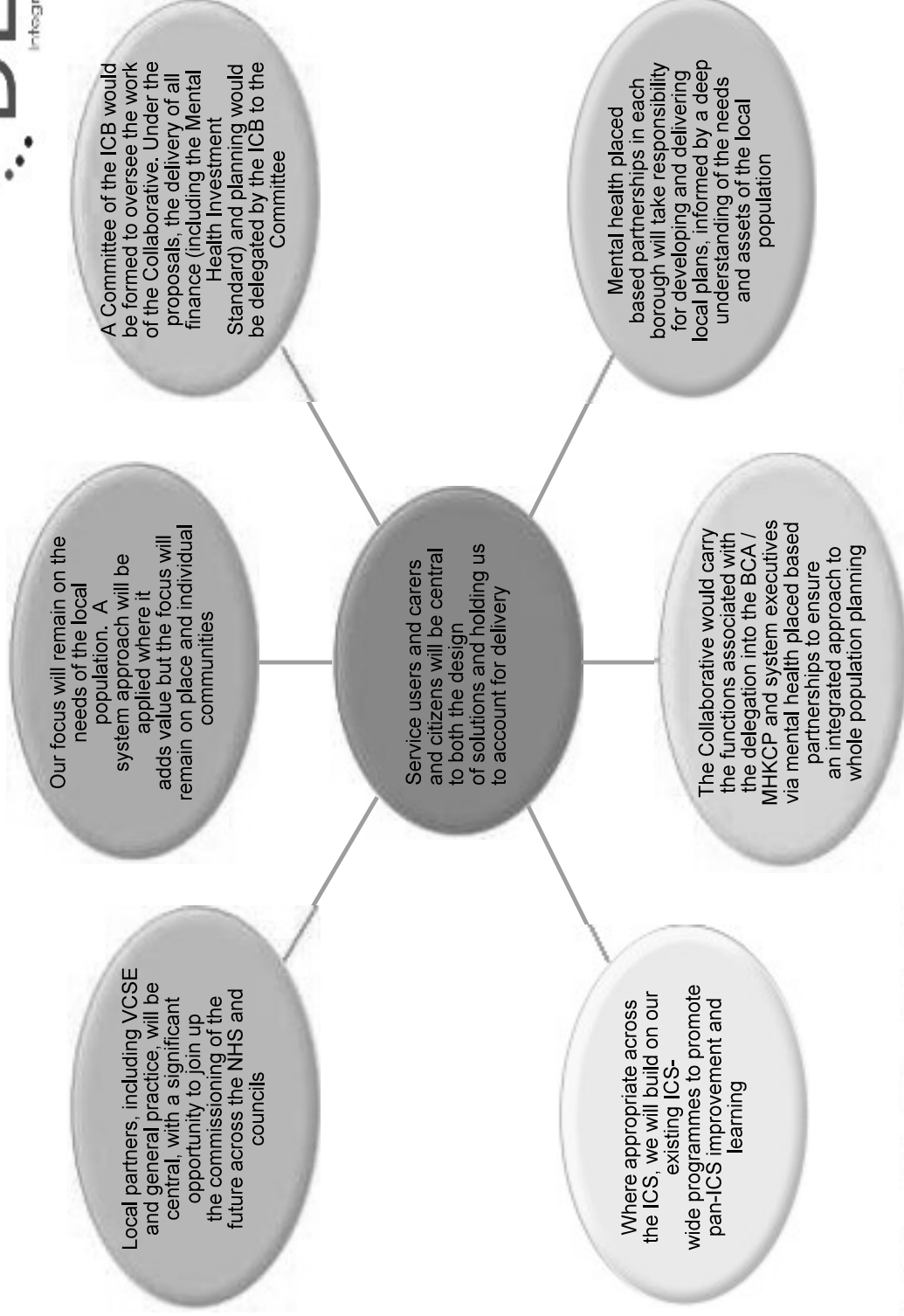

Areas of focus/priorities identified to date



Areas where we could make progress more quickly through deeper collaboration may include:

- **Prevention & wider determinants:** working with partners to design and deliver up prevention plans that explicitly tackle inequity in outcomes for our communities and focus on our Marmot commitments to tackle the social determinants of health
- **Workforce:** developing and enacting a robust workforce plan more effectively together
- **Children & young peoples mental health:** re-modelling our care offer in light of demand pressures and grasping the huge opportunity to develop Tier 4 beds, joining up admission avoidance development with LA and acute partners
- **Accommodation care pathway:** defining and developing accommodation care pathways & market management across health and social care to improve quality and outcomes
- **Population health management (PHM):** using PHM to drive focus on the opportunities to achieve the triple aim for people with mental and physical health co-morbidities. Working at place and scale, with PHM, to focus on how we reduce avoidable health inequalities for our populations
- **Urgent and Emergency Care (UEC):** working with system partners to address the challenges of increased demand and acuity in UEC, ensuring that patients are supported in the best environment
- **Learning Disabilities and/or Autism:** working across the system to improve access, pathways and overall experience of people with LDA in BLMK
- **NHS Long Term Plan (LTP) delivery:** progress made but we still have challenging areas that we believe we can deliver on better together ensuring LDA receives the same focus
- **Specialised services:** there is an opportunity to more effectively organise our system interface with the East of England Mental Health Collaborative, to improve pathways and better outcomes



Next steps: design through co-production

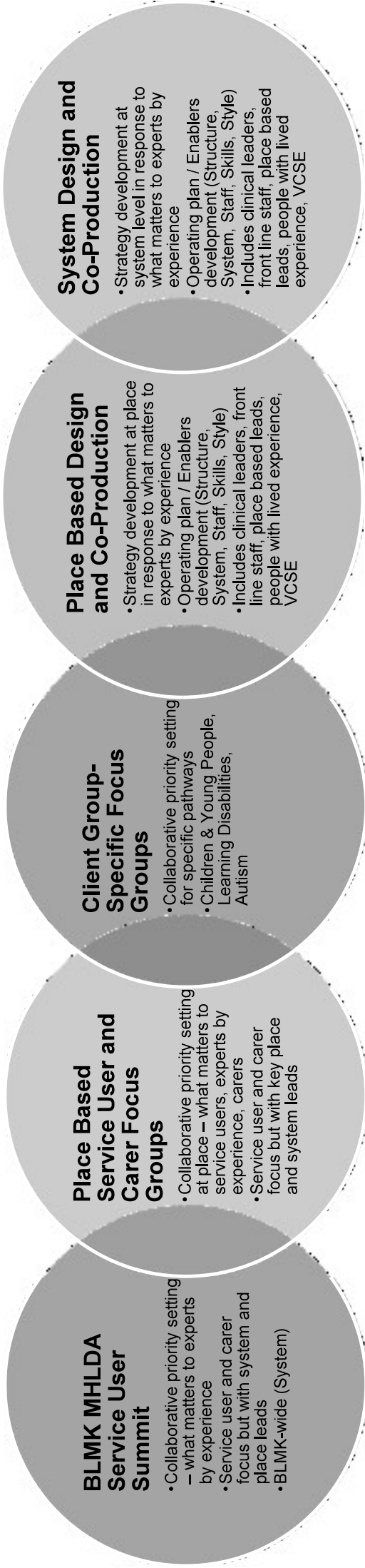

Collaborative Development Process – Starting with “What Matters to Service Users and Carers”



Community Engagement

Item 10 Briefing for the BLMLK Health and Care
Partnership

Michelle Summers, Associate Director
Communications and Engagement

7 March 2023

Help us to shape our work

- The purpose of this presentation is to share with you the new partnership approach we're taking to working with people and communities
- To demonstrate how we're pooling our engagement resources from local authorities through to NHS, Healthwatch and the VCSE to remove duplication
- To ask for your help – as democratically elected leaders and community leaders
- Help us shout about how we're making a difference to residents in our area.



A new partnership approach

In November 2022, the Working with People and Communities Strategy was approved by the ICB.

The strategy aims to put lived experiences at the heart of our work and give people the opportunity to shape the services they receive.

Today I'm going to update you on:

- work ongoing as part of this strategy
- what engagement is coming up; and,
- how you can be fully involved

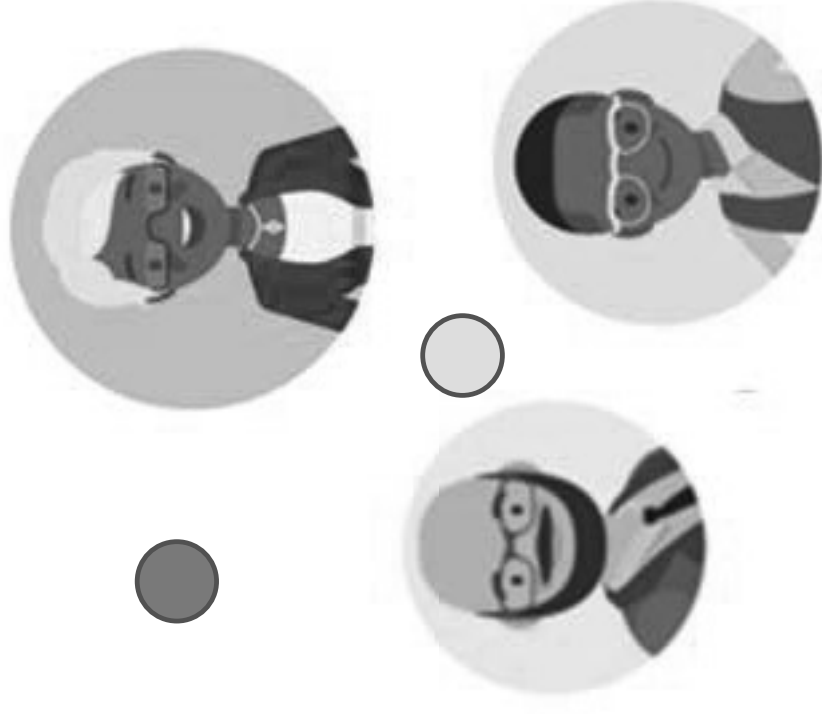

What did we set out to achieve?

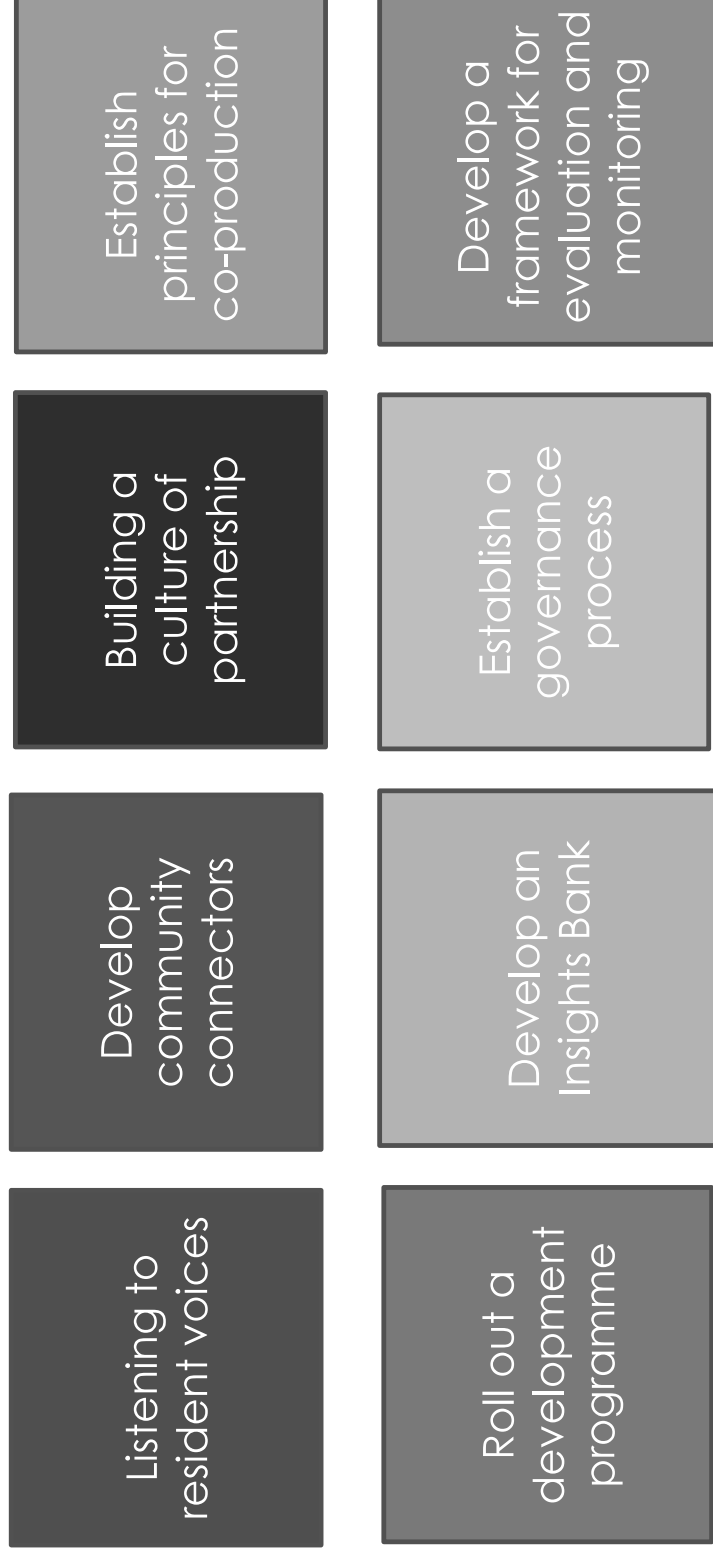

Engaging with residents and listening across the whole system

- Joint Forward Plan – bringing together what we've heard from partners
- Denny Review of Health Inequalities
- Luton 2040 event/The fairness Charter in Luton / Talk, listen, change.
- MSK engagement with service users
- Digital engagement with D/deaf community and digitally excluded
- Evergreen co-production
- ELFT Co-production simulator
- Mental Health summit – Police, Fire, Council, NHS
- Listening to the Gypsy, Roma & Traveller community
- Healthwatch Luton – LGBTIQ events
- Disability seminar



Developing community connectors

- Through the health inequalities workstream, we're developing community connectors.
- Healthwatch as a strategic partner
- VCSE partnerships
- Community leaders including Councillors, faith leaders etc.



Building a culture of partnership

- Local Authority, NHS, Police, Fire, VCSE and Healthwatch established a Community of Practice to share insights and resources.
- Shared approach to campaigns e.g. winter/heat health.
- Agreed shared principles across the system around co-production including a framework.
- MOU with Healthwatch and VCSE



Principles of co-production

Shared policies and strategies from partner organisations to agree:

- Single definition of co-production
- An agreed co-production framework
- Agreement on training and development
- Developing a policy for remuneration of participants
- Establishing a network of participant leads for BLMK



A development programme

- We are working with the Consultation Institute to deliver co-production training.
- 246 people have been through the programme in three months with leadership team booked to attend.
- Bi-monthly community of practice webinars



Doing more with our insights

- There is an appetite across the system for sharing insight to better inform planning and resource allocation.
- We're working closely with partners like the Police & the Fire and Rescue Service on community engagement and insight, and with our Local Authority partners
- Each organisation has rich insight, and by working in partnership we can make these insights count for more
- This includes working with NHS Trusts to use patient feedback mechanisms (I want Great Care / Friends and Family Test etc.)
- We're interested in procuring the tech to better log and analyse community insights – we've done a lot of market research, but the technology isn't quite good enough yet.

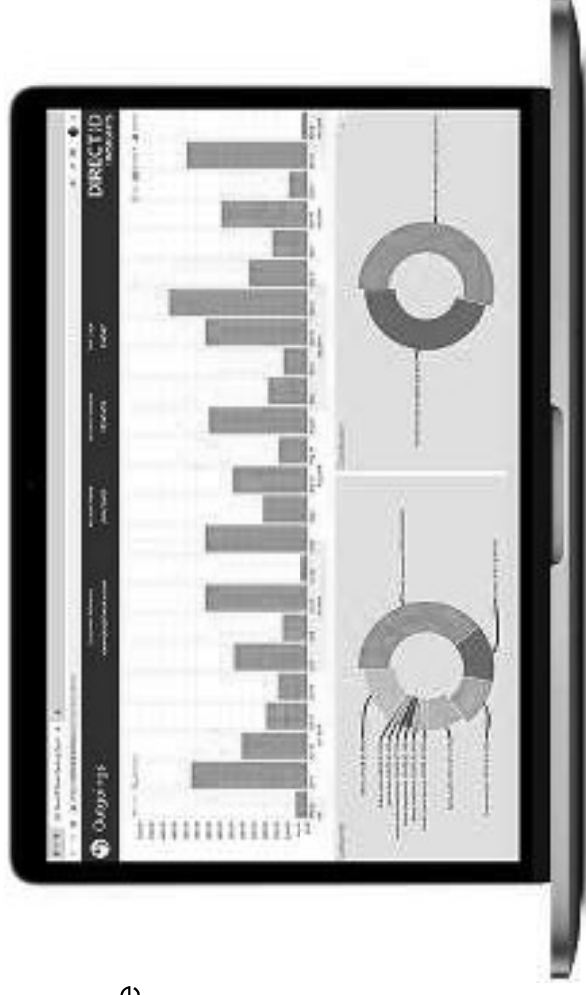

Establish governance process

- Established a policy for Working with people and communities aligned to ICB Constitution.
- Established Working with People and Communities Committee – formal committee of the ICB.
- Committee includes leaders from across the partnership.
- Development of a workplan for the system



Evaluation and monitoring

- We want to know what residents think about our partnership and our performance locally.
- We monitor all media and parliamentary coverage.
- New to the ICB – an annual benchmarking survey to monitor resident and stakeholder views.



What has worked well?

- Sharing of best practice and resources
- Working through trusted partners
- Going to where people are/where they go
- Specific questions – not open ended about ambitions
- Playing back – how this is making a difference
- Taking action



We want a better view of what engagement is happening



We are developing a forward look of engagement across the ICS for 23/24, and welcome partner support.

Engagement / Co-production work		How?
Partner		
BLMK ICB	Co-production – Fuller neighbourhoods	TBC
BLMK ICB	Joint Forward Plan – focused engagement with e.g. people affected by serious violence alongside wider on priorities for 2024/5	Face to face engagement with residents
BLMK ICB	Same Day access	Co-production TBC
Central Bedfordshire Council	Accommodation Strategy for older people	Series of workshops with older people
Camb Community Services	Transitions and epilepsy engagement with young people	Focus groups / app testing accessibility

We want a better view of what engagement is happening



Engagement / Co-production work		How?
BLMK Maternity Voices	Conception and pregnancy	Events and workshops
Camb Community Services	Neuro diversity in females	Project group engagement
Bedfordshire Hospitals	Inclusive language – Maternity Services	Patient survey
Healthwatch listening events (MK/CB/LTN/BB)	Women’s health, menopause, Carers, LGBTIQ, End of Life and Palliative care, maternity services, community support	Events

We want a better view of what engagement is happening



Roma Trust	Engagement on health inequalities	Focus groups and interviews
Denny Review	Co-production with Health and Care Professionals	Workshops
Steering Group		

Get involved



Contact Michelle Summers on michelle.summers2@nhs.net

Thank you

Any questions?

If you have want to share good news with us, or
get involved in our work, please contact
michelle.summers2@nhs.net

BLMK Health and Care Partnership Forward Plan 2022-23

	4 July 2022 10-11.30am MS Teams	21 September 2022 5-8pm Central Bedfordshire Council	14 December 2022 2-5pm Bedford Borough Council	7 March 2023 5-8pm Milton Keynes Council
Public Meeting Agenda Items				
Report Deadline		Noon 9 September 2022	Noon 2 December 2022	Noon 23 February 2023
1	Terms of Reference	Terms of Reference – appointment of Deputy Chair	Joint Strategic Needs Assessment	Health and Care Strategy and five year forward plan - update
2	Integrated Care Strategy progress update	Integrated Care Strategy progress update	Draft Integrated Care Strategy	Dentistry – current position and follow up in 6 months
3	Review of Shadow Meeting	Research and Innovation in BLMK	Update from Place	Community engagement – clarification what to be covered
4		Draft VCSE Memorandum of Understanding	Integrated Care Board update	Mental Health, Learning Disability and Autism collaboration – learning so far
5			The Fuller Programme - Delivering Integrated Care	Health and Wellbeing Board guidance
6	Work plan	Work plan	Work plan	Place delivery plan – HWBB Chairs to present – could include Healthwatch community engagement plans for 2023
				ICB update – for information

				Work plan – for information
--	--	--	--	-----------------------------

Next meeting June 2023

- VCSE sector summary of activities in BLMK and actions taken on the ICB and VCSE Memorandum of Understanding
- Children & Young People

September 2023

- Health and Care Strategy – feedback from the community on impact